

META<sup>®</sup>

SPORTING GOODS

HURDLES AND LADDERS .....	03
CONES AND POLES .....	08
GOAL POSTS .....	16
DEFENDERS DUMMIES .....	18
TRAINING .....	21
REBOUNDERS .....	26
GYM .....	30
REFEREE .....	37
ACCESSORIES .....	39
TACTIC BOARDS .....	44
BAGS .....	47
FIRST AID .....	50
BALLS .....	52

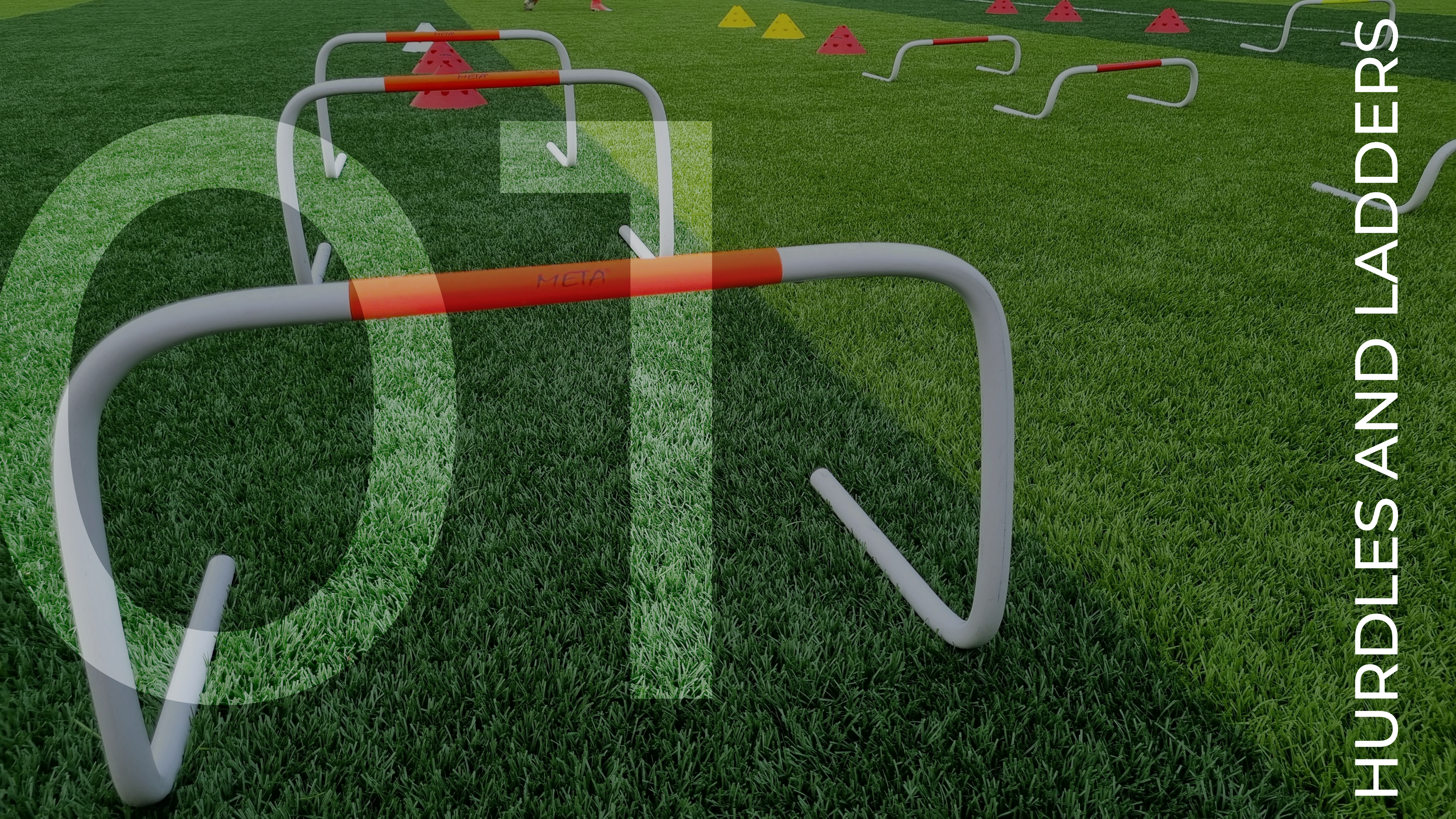

# HURDLES AND LADDERS



## SPEED HURDLE

The Speed Hurdle is constructed from high-strength PVC tube, making it both durable and lightweight. It is an excellent product for improving leg speed and physical coordination. With a range of heights available (from 10 to 45 cm), it allows for versatile and progressive exercise sessions. Whether you're seeking to enhance agility, speed, or overall physical coordination, this Speed Hurdle is a valuable and versatile training aid.

- |                    |                    |
|--------------------|--------------------|
| ART.               | ART.               |
| 1100401240 – 10 CM | 1100411240 – 10 CM |
| 1100601525 – 15 CM | 1100611525 – 15 CM |
| 1100901540 – 23 CM | 1100911540 – 23 CM |
| 101201500 – 30 CM  | 1101211500 – 30 CM |
| 1101501210 – 38 CM | 1101511210 – 38 CM |
| 1101801240 – 45 CM | 1101811240 – 45 CM |

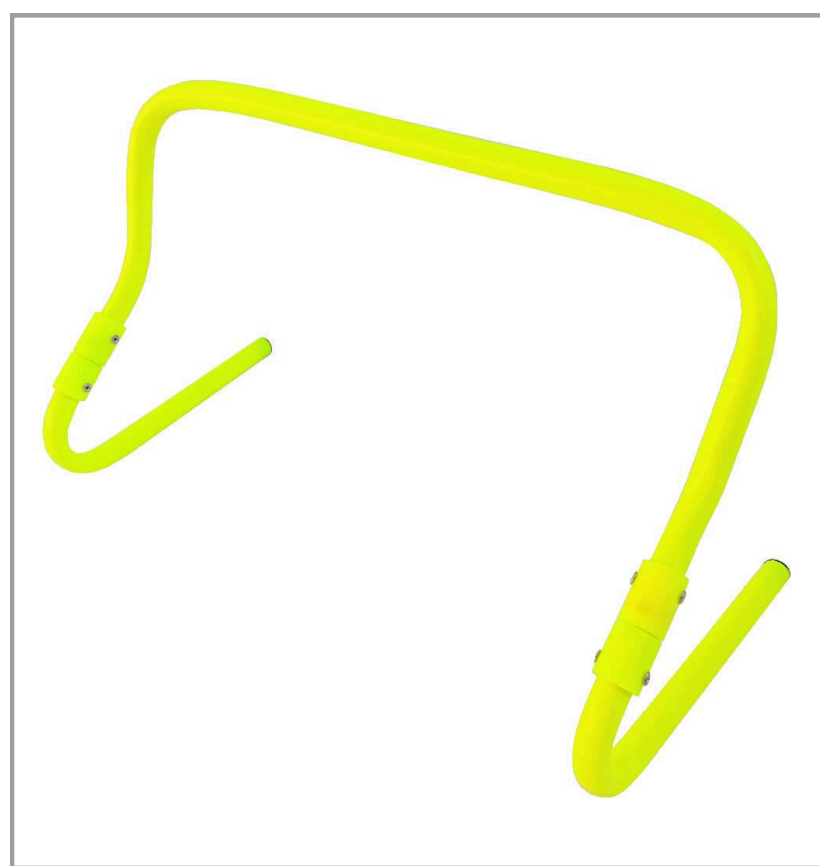

## SPEED HURDLE ADJUSTABLE 15 – 30 CM

The Speed Hurdle Adjustable is versatile one-color hurdle and designed to help athletes improve their leg speed and jumping abilities. With adjustable heights of 15 and 30 cm and a width of 45 cm, it offers flexibility for various training needs. The two-way leg movement allows for easy adjustment of the height, and the legs fold down for convenient portability. The high-visibility color makes it suitable for use in different lighting conditions and training environments. The durable construction ensures long-lasting use for track and field training, plyometrics, and agility drills.

ART. 1106122005

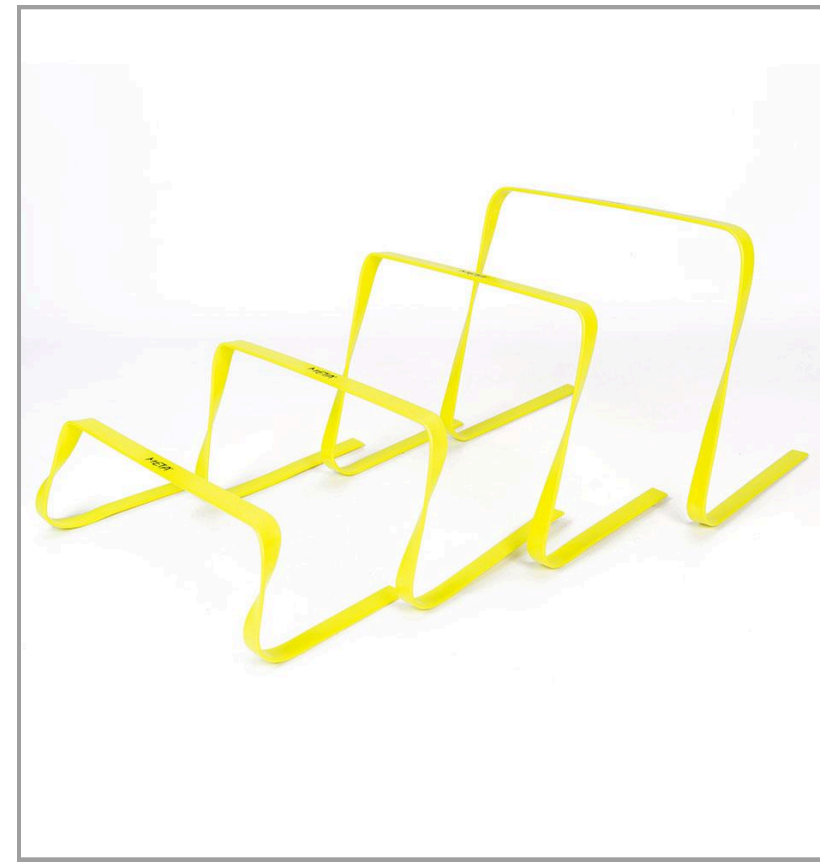

## FLAT AGILITY TRAINING HURDLE

The Flat Agility Training Hurdle is a durable and versatile PVC tube hurdle designed for a variety of athletic and fitness exercises. The high-strength solid construction makes it perfect for agility drills, plyometric jumps, and speed training. Meanwhile its flat and lightweight design allows for easy transport and setup for different workout routines. The PVC tube's quick recovery feature ensures that it maintains its shape and durability, even after repeated use or impacts. It is available in heights of 15cm, 23cm, 30cm, and 38cm, with a standard width of 40cm, catering to different training needs and progressions for athletes at any level.

- ART.
- 1100612320 – 15 CM
  - 1100912320 – 23 CM
  - 1101212300 – 30 CM
  - 1101512200 – 38 CM



## AGILITY HURDLE BOUNCE BACK

The Agility Hurdle Bounce Back is durable structure hurdle and an excellent tool for leg training, jump exercises, and stretching routines. It is designed to withstand rigorous workouts and is particularly ideal for enhancing agility, strength, and flexibility. A notable feature of this hurdle is its ability to return to its initial state after being overturned, allowing for seamless, uninterrupted workouts. With a width of 60 cm and available in heights of 20 cm, 30 cm, and 40 cm, this hurdle offers versatility for various fitness needs. It is a valuable addition to any training regimen for professional athletes.



- ART.
- 1102012200 – 20 CM
  - 1103012200 – 30 CM
  - 1104012100 – 40 CM



## PLYO HURDLE

The Plyo Hurdle is a versatile training tool. Made of heavy-duty fabric and a wooden board, this hurdle is available in various sizes from 15 to 38 cm with a standard width of 45 cm. It helps improve explosiveness, speed, and overall power in movements such as jumping and sprinting, making it a valuable tool for both athletes and fitness enthusiasts. The adjustable height allows for progressive overload and customization based on an individual's strength and skill level. It is a portable and easy-to-set-up tool suitable for use on a track, in a gym, on a court, or on a football pitch.

- ART.  
 2006501005 – 15 CM  
 2009501005 – 23 CM  
 2012501005 – 30 CM  
 2015501005 – 38 CM

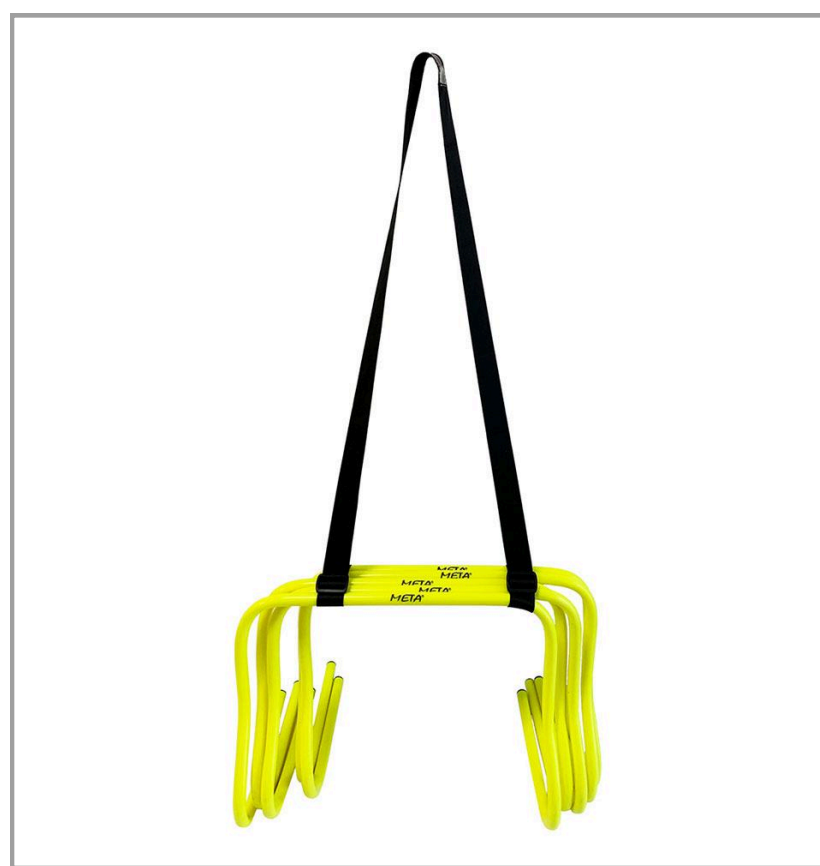

## SHOULDER HURDLE CARRY STRAP

The Shoulder Hurdle Carry Strap is designed to facilitate the transport of multiple slalom, training poles or hurdles, with a recommended carrying capacity of 5 to 8 units. Equipped with two plastic handles for securing the sports equipment, the shoulder hurdle carry strap measures 190 cm in length and 4.5 cm in width. Constructed from durable and lightweight polyester material, it allows for convenient carrying without adding extra weight. The adjustable design enables users to customize the fit for comfort and ease of use, making it a practical tool for coaches or athletes in need of effortless equipment transport.

ART. 1100215100



## HURDLE CARRY STRAP

The Hurdle Carry Strap is a convenient for carrying multiple hurdles, slalom or training poles. It is adjustable and made of durable material, capable of carrying from 6 to 8 hurdles or poles at once. This strap offers convenience and efficiency, making it perfect for having it on a track, a court or a football pitch, or other sports where transporting equipment is necessary. Save time and effort with this practical solution for transporting.

ART. 1100115100

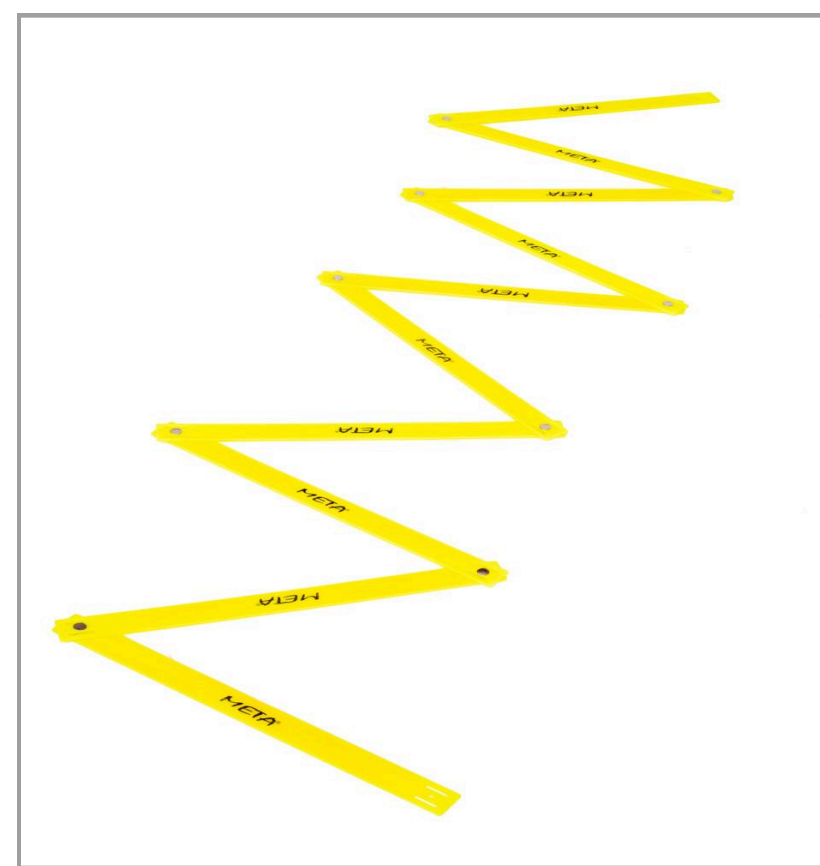

## AGILITY SMART CRISS-CROSS LADDER

The Agility Smart Criss-Cross Ladder is specifically designed for a wide range of training exercises due to its adjustable steps, making it suitable for agility drills, footwork training, and speed drills. Available in lengths of 4m or 8m, the ladder features 4mm thick, 3.5cm wide, and 41cm long steps. It is constructed of durable and weather-resistant materials, suitable for both indoor and outdoor use. The ladder's portable design allows for convenient transportation and setup, and it comes with a branded handy bag for easy storage.

- ART.  
 1000011975 – 4M (10 STEPS)  
 1000021975 – 8M (20 STEPS)

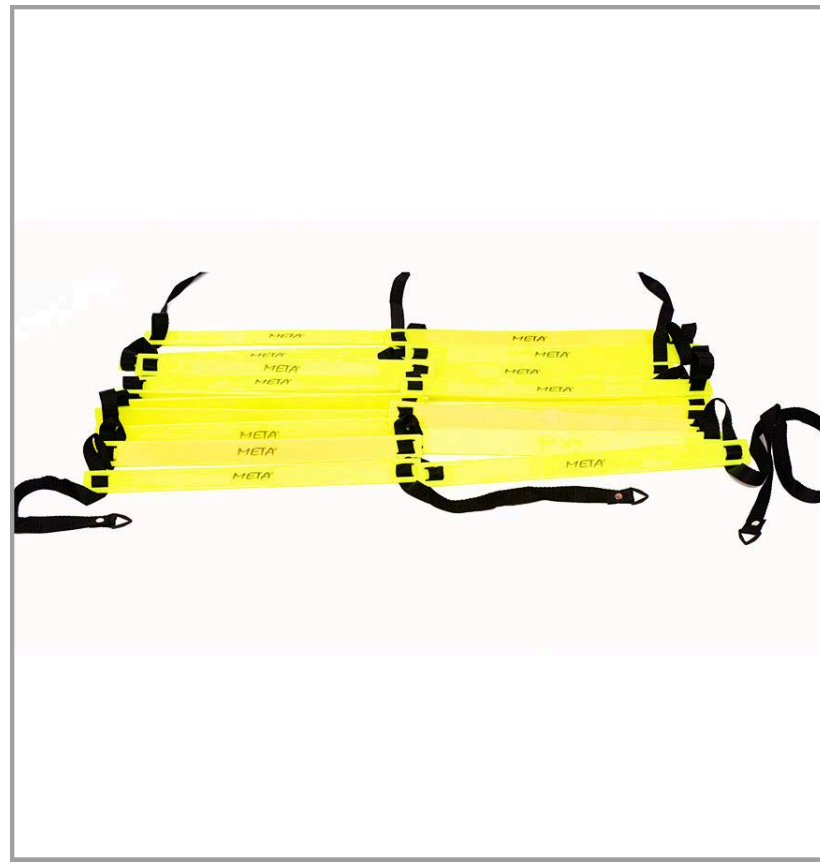

## DOUBLE FLAT SPEED LADDER 4M

The Double Flat Speed Ladder is made of durable belt nylon fabric with flat adjustable plastic steps that are 4 mm thick and 3.5 cm wide. The ladder is 4 meters long and has 10 rungs. Its unique double ladder design allows for a wide range of agility exercises. It comes with a branded bag for convenient storage. Perfect for agility training, speed drills, and footwork exercises, this ladder is suitable for athletes, fitness enthusiasts, and individuals in physical therapy. The adjustable design makes it suitable for users of different fitness levels.

ART. 1000405108

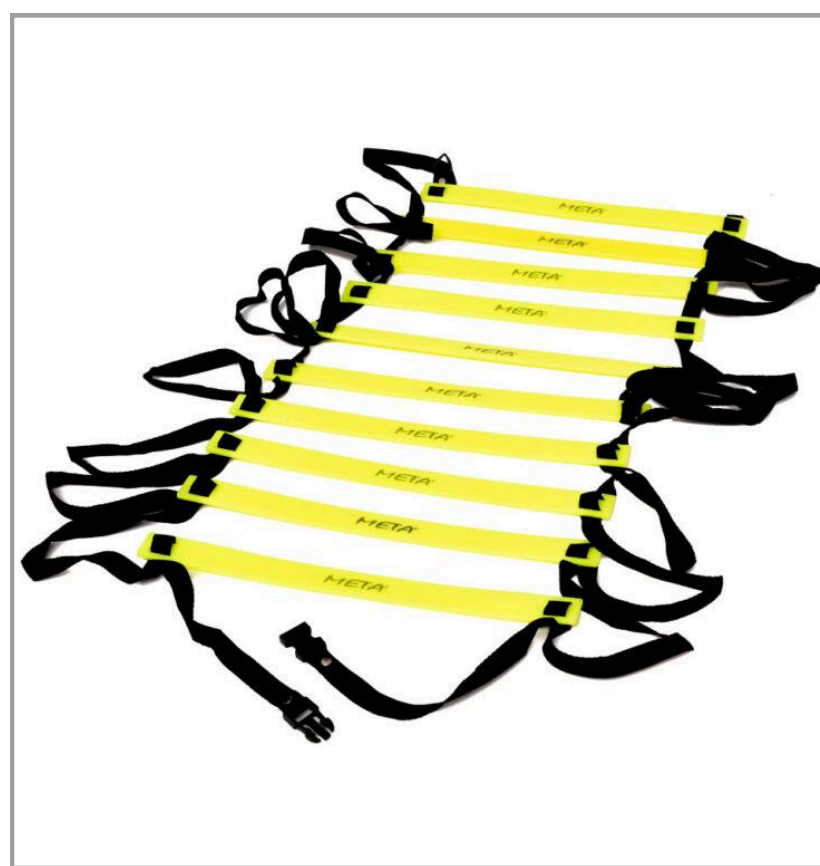

## SPEED LADDER PRO FLAT

The Speed Ladder Pro Flat is constructed from durable belting nylon fabric and features adjustable flat plastic steps that are 4mm thick and 3.5cm wide. The ladder has a width of 41cm and can be extended using connecting clips at its ends. It is available in three different lengths: 4m with 10 rungs, 6m with 15 rungs, and 8m with 20 rungs. Additionally, the ladder comes with a branded carry bag for convenient transportation. This versatile and practical ladder is suitable for a variety of uses and environments.

ART.  
 1041001100 – 4M (10 STEPS)  
 1061501108 – 6M (15 STEPS)  
 1082001108 – 8M (20 STEPS)

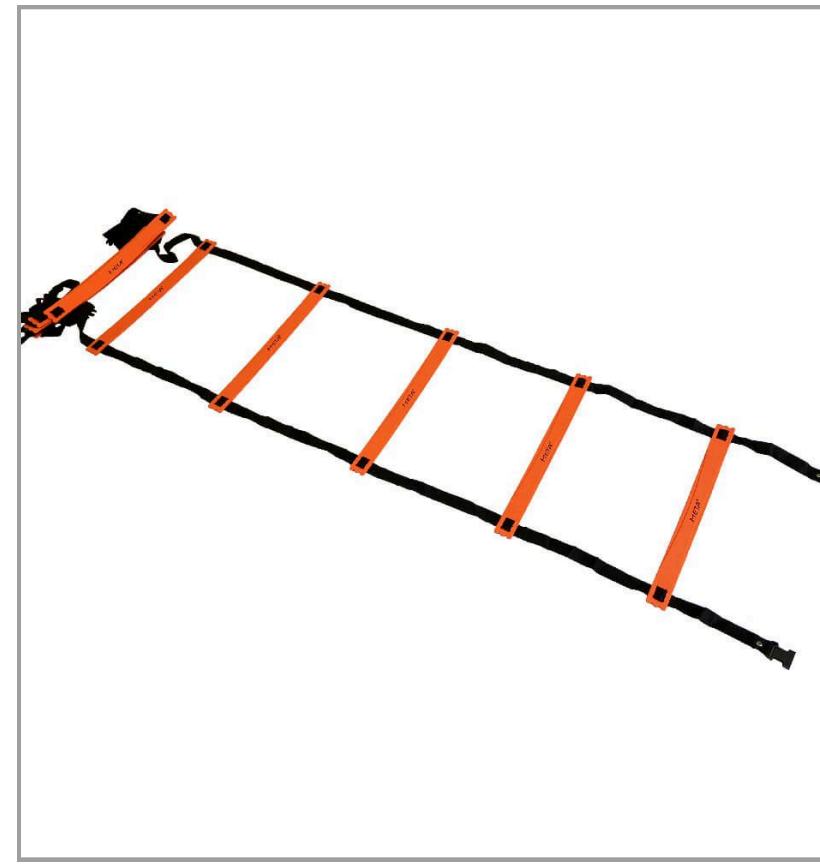

## INDOOR LADDER WITH ANTI SKID STEPS

The Indoor ladder with anti skid steps is a top-quality agility ladder made of durable nylon fabric and features adjustable flat rubber rungs that are 4mm thick and 4cm wide. The ladder is 42cm wide, making it perfect for coordination training in gyms, on court floors, or any other flat surface indoor. The rungs are designed with non-slip surfaces, providing an ideal tool for agility and speed training. It is available in two sizes: 4m with 10 rungs and 8m with 16 rungs, and can be extended using plastic staples on the edges. Additionally, it comes with a branded bag for easy transportation and storage.

ART.  
 4000001860 – 4M  
 4000001856 – 8M

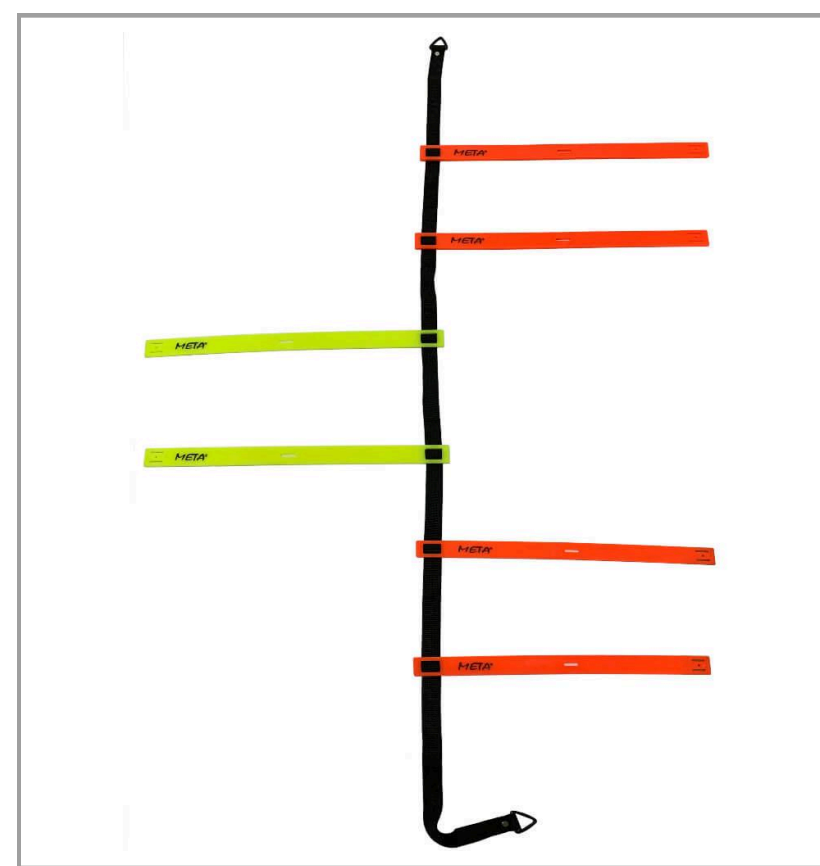

## GOALKEEPER COORDINATION LADDER

The Goalkeeper Coordination Ladder is specifically designed to enhance footwork, agility, and coordination skills for goalkeepers. It is constructed with durable belting nylon fabric and measures 3.5 meters in length, featuring 6 adjustable plastic steps, each 50cm in length. The ladder is widely utilized for practicing one and two-step techniques. It comes with a branded carry bag for convenient transportation. This Goalkeeper Coordination Ladder is an essential tool to improve your performance on the field for beginners or a seasoned goalkeepers.

ART. 2001005002

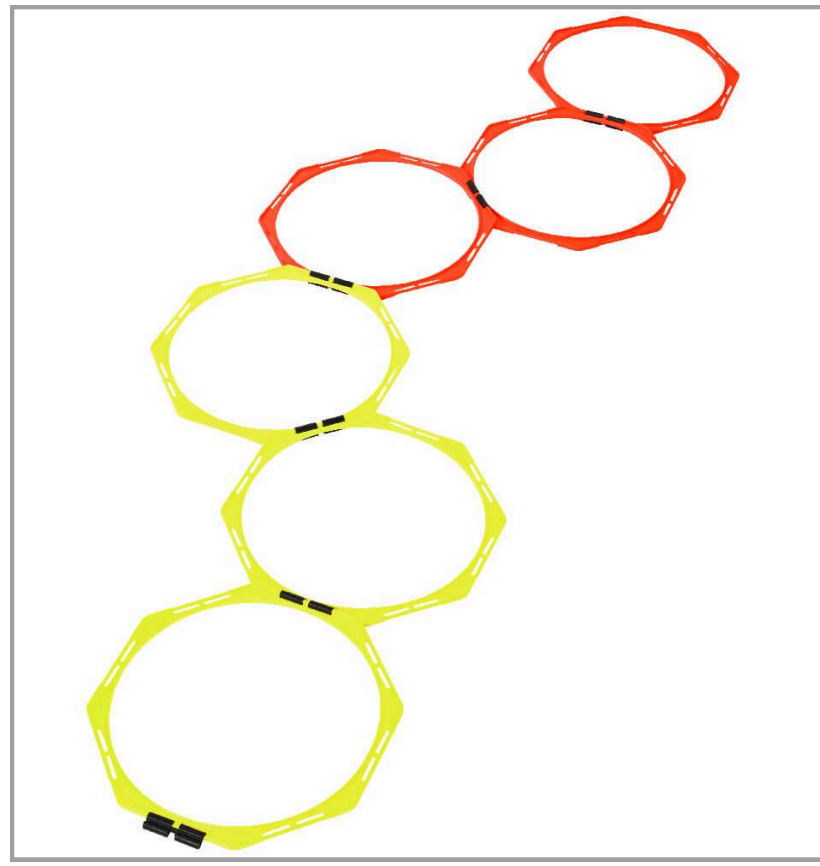

## OCTAGON LADDER

The Octagon Ladder is constructed with 6 flexible octagonal rings of two different colors, each with a thickness of 5 mm and a width of 2 cm. The rings are made of high-quality plastic and are interconnected by 6 special plastic clips, allowing for customizable training exercises and variability. The ladder is supplied in a branded carry bag for easy transport and storage. Each ring measures 49 x 49 cm in inside dimensions. This training tool is suitable for improving agility, coordination, and overall fitness for athletes and fitness enthusiasts.

ART. 1100001250

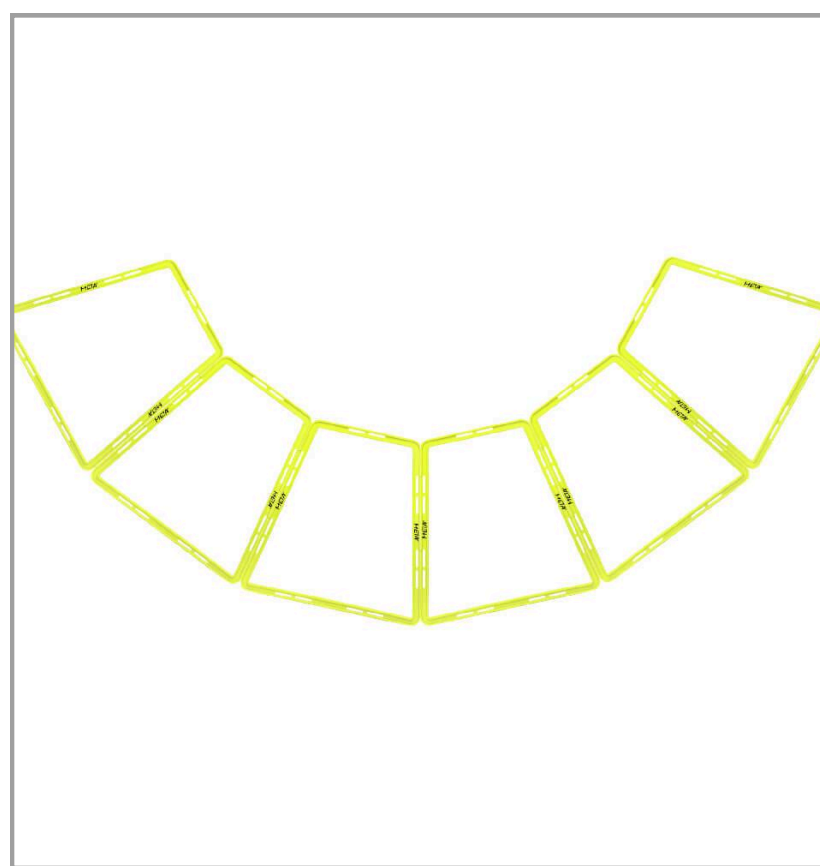

## TRAPEZOID RINGS SET OF 6

The Trapezoid Rings set is an essential product for improving coordination, agility, and multidirectional movement in training. Made of heavy-duty plastic, the trapezoidal design enhances curvilinear movement, zig-zag running, and multidirectional coordination for various sports and fitness activities. The set includes 6 rings, set of plastic clips for these rings fixation and a branded carry bag for easy transportation and storage. It is perfect for both indoor and outdoor training sessions. The set is a valuable addition to any training regimen.

ART. 1200001250

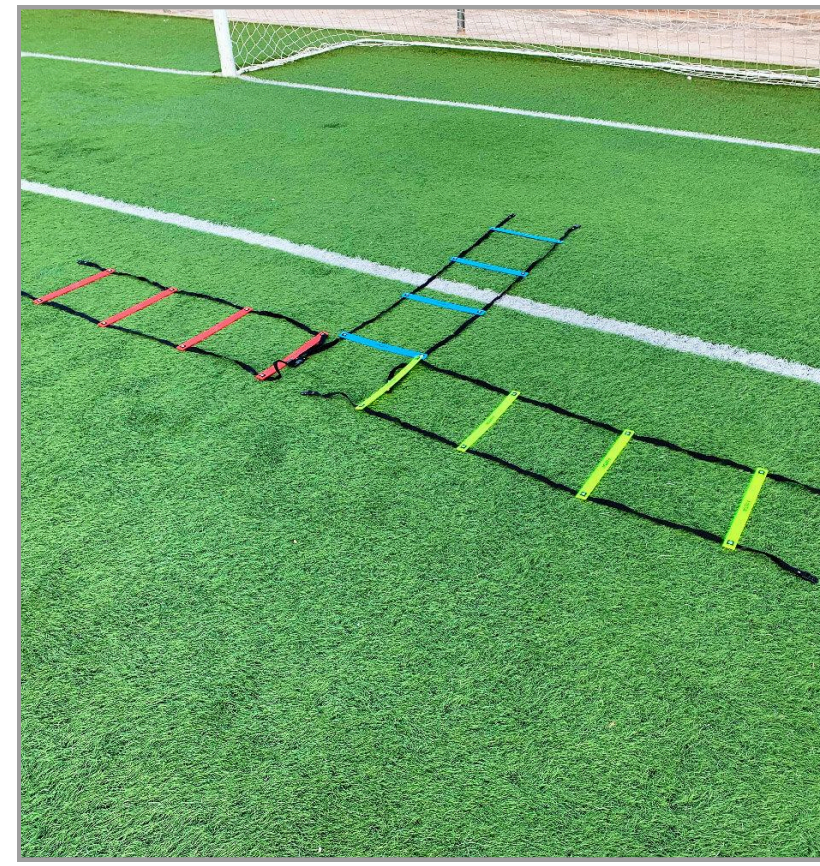

## MINI AGILITY GOALKEEPER LADDER

The Mini Agility Goalkeeper Ladder is a specially designed tool to help goalkeepers improve their agility, speed, and balance. This product consists of three ladders, each measuring 2.4 meters in length, with 4 flat fixed steps. The ladders fix together using special plastic connectors and come in vibrant colors for better visibility during drills. The set also includes a branded carry bag for easy transportation and storage. These ladders are made of high-quality, durable materials, making them suitable for use on various surfaces, both indoors and outdoors. They are essential for goalkeepers looking to enhance their footwork and overall performance.

ART. 2001002001





# CONES AND POLES

## TRAINING POLE

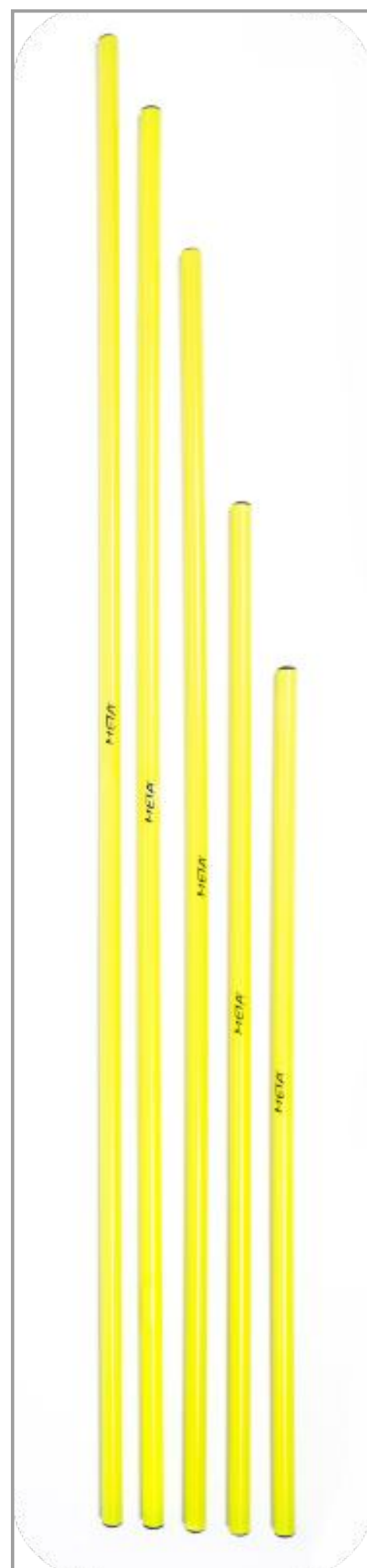
The Training Pole is a versatile and durable piece of equipment used in various sports and athletic training. Made of high-strength PVC tube with a diameter of 25mm, it is available in different lengths, ranging from 80 to 180 cm. Its bright colours ensure high visibility in all weather conditions, making it suitable for outdoor use. Training Poles are widely used in many training sessions to improve athletes' agility, speed, and precision. The poles can be easily inserted into a base for stability, making them practical for use in different training settings.



 ART.  
1258025200 – 80 CM  
1251002520 – 100 CM  
1251202520 – 120 CM  
1225152253 – 152 CM  
1225180253 – 180 CM

 ART.  
258025204 – 80 CM  
1251002524 – 100 CM  
1251202524 – 120 CM  
1225152254 – 152 CM  
1225180254 – 180 CM

 ART.  
1258025203 – 80 CM  
1251002523 – 100 CM  
1251202523 – 120 CM  
1225152255 – 152 CM  
1225180255 – 180 CM

 ART.  
1258025201 – 80 CM  
1251002521 – 100 CM  
1251202521 – 120 CM  
1225152251 – 152 CM  
1225180251 – 180 CM

 ART.  
1258025202 – 80 CM  
1251002522 – 100 CM  
1251202522 – 120 CM  
1225152252 – 152 CM  
1225180252 – 180 CM

## SLALOM POLE SIMPLE SPIKE

The Slalom Pole Simple Spike 170 Cm is a pole features a traditional design with a 25mm PVC tube and an aluminum spike. The 180cm length, including the spike, makes it suitable for users of all ages. The spike's tip is covered with a removable cap for safety. Whether for setting up agility drills or obstacle courses, this versatile and durable pole is perfect for various training and recreational activities.

ART. 1200001200

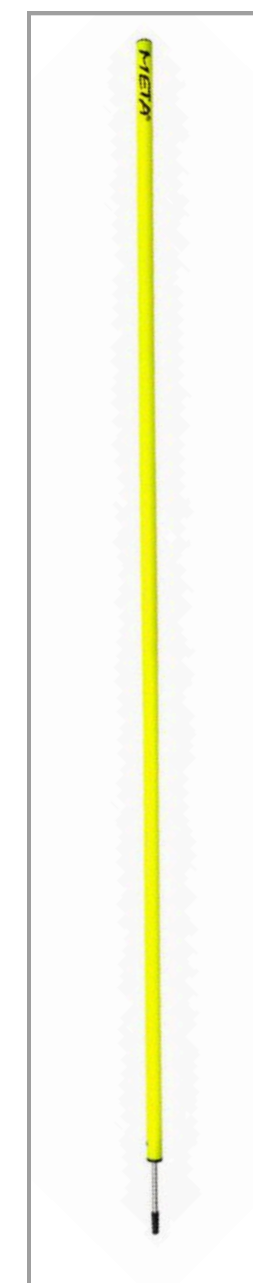

## PREMIUM SLALOM POLE SIMPLE SPIKE

The Premium Slalom Pole Simple Spike is designed for professional teams and athletes, featuring a traditional shape and heavy-duty PVC construction. The stainless steel spike includes a removable cap for user safety. With a 32mm diameter and a length of 170cm (180cm with the spike), this slalom pole meets the technical requirements for professional use. Its durability and performance make it a top choice for training drills.

ART. 1210001200

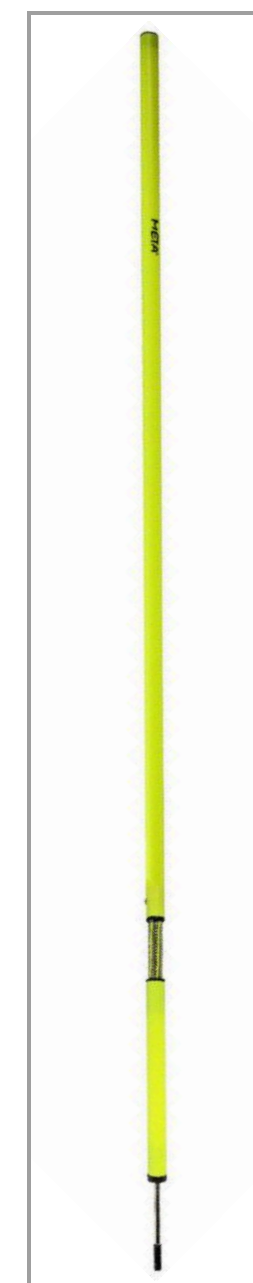

## PRO SPRING SLALOM POLE

The Pro Spring Slalom Pole is designed to provide a stable training experience. Its 25 mm PVC construction, combined with an elevated spring at 25 cm from the base, offers durability, resistance, and reduced swinging motion. The poles are 170 cm in length without the metal spike, and 180 cm with it. Overall, the Pro Spring Slalom Pole is a popular and reliable option for training on football pitches.

ART. 1200014200





## RUBBER BASE CLASSIC

The Rubber Base Classic, made of high-strength rubber, is specifically engineered for installing 25mm diameter training poles. With a weight of 1.5 kg, a diameter of 24 cm, and a height of 14 cm, this base provides a stable foundation for training poles during training. Its durable construction allows for use in both indoor and outdoor environments, making it suitable for any surface.

ART. 1200000200



## RUBBER BASE 2 HOLE

The Rubber Base-2 Hole is designed for stability and convenience during exercise sessions. It weighs 1.5 kg, ensuring it remains firmly in place, and its high-strength rubber construction allows for both indoor and outdoor use. With a diameter of 22 cm and a height of 8 cm, the base provides a sturdy foundation for the installation of two 25mm diameter training poles at the same time and in different directions. This makes it versatile for a variety of exercise routines.

ART. 1200023200



## RUBBER BASE SHORT

The Rubber Base Short has a short top, making it easy and convenient to install. The poles suitable for use with this base have a diameter of 25mm. The base itself is a sturdy high-strength rubber construction, weighing 1.3kg and with a diameter of 23cm. This durable base is suitable for use both indoors and outdoors, offering versatility for training in various environments.

ART. 1200033200



## RUBBER BASE MULTI DIRECTION

The Rubber Base-Multi Direction is designed for stability and convenience during exercise sessions. It weighs 1.5 kg, ensuring it remains firmly in place, and its high-strength rubber construction allows for both indoor and outdoor use. With a diameter of 22 cm and a height of 8 cm, the base provides a sturdy foundation for the installation of three 25mm diameter training poles at the same time and in different directions. This makes it versatile for a variety of exercise routines.

ART. 1200003200



## MULTI ANGLE DOME BASE

The Multi Angle Dome Base has an innovative design that allows for versatile configurations, accommodating 25mm and 30mm training poles, slalom poles and flat agility rings. The option to fill the base with sand or water ensures stability during use, while the design also allows for the attachment of equipment from different angles, enabling a wide range of exercises. With a 20cm diameter and 10cm height, the base is compact and portable, making it a convenient addition to any training regimen.

ART. 1200025300



## MARKER CONE OCTAGON SET OF 50

The Marker Cone Octagon Set with an innovative octagonal design, specifically crafted for agility training and speed drills. These markers are made of soft plastic, providing durability and safety for athletes. They can be used with training poles to assemble hurdles of different heights. Each marker measures 5 cm in height and 20 cm in base width. The set includes 50 pieces, and a special stand is provided for convenient storage and transportation. These markers are versatile and suitable for various sports, making them an essential training tool for coaches and athletes alike.

ART. 1800005060

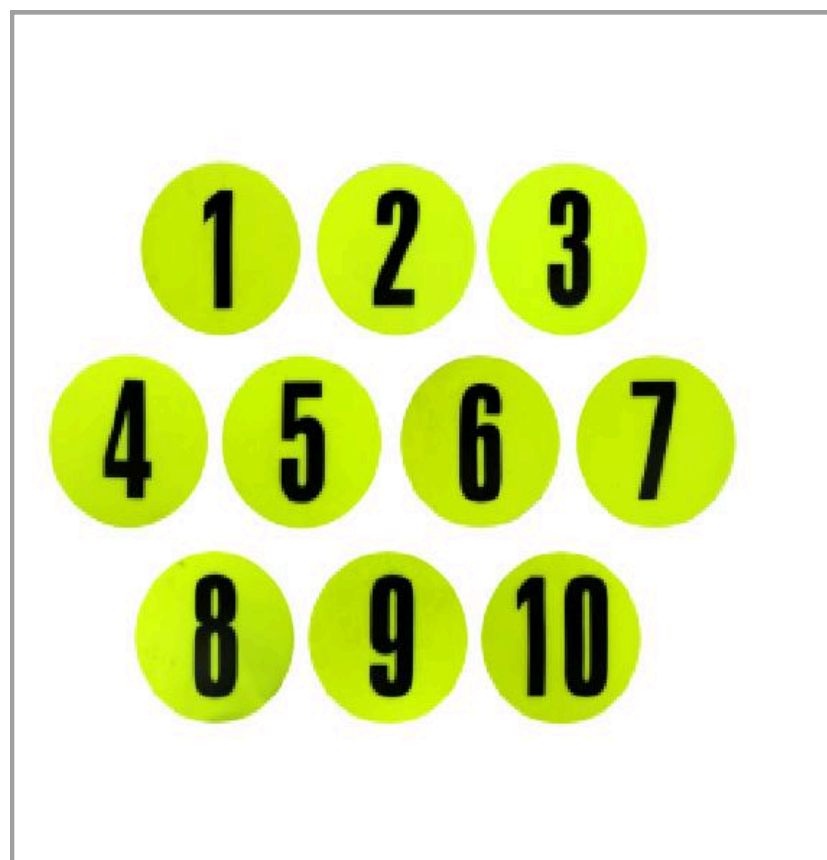

## FLAT NUMBER MARKER SET OF 10

The Flat Number Marker Set is a set of 10 anti-skid flat markers, an essential tool for training and coaching in various team sports. Each marker is constructed from TPR material and is 12.5 cm in diameter, featuring printed numbers 1 through 10. The anti-skid design ensures stability during use, while the flat structure minimizes the risk of tripping and injury. These markers conveniently come in a branded bag for easy storage and portability. Perfect for enhancing player movement and coordination on the pitch.

ART. 2002005004



## MINI SPACE MARKER SET OF 30

The Mini Space Marker Set consists of 30 flexible, multi-purpose markers in vibrant colors. Each marker is made of high-quality soft plastic and measures 3.5 cm in height with a 13 cm diameter at the base. The set includes markers in three different colors, providing versatility for various applications. Some coaches like using them to complicate training tasks on a pitch or a court.

ART. 1803025160



## FLAT MARKER WITH HOLE SET OF 10

The set of Flat Markers with holes is a set of non-slip flat markers and is a practical training product for athletes. The rings design allows for quick and easy collection, and with the ability to store approximately 50 markers on your arm at once, setting up and tidying away training sessions are fast and efficient. These markers are non-marking and can be used on a variety of surfaces, making them perfect for indoor and outdoor workouts. The set includes 10 markers, each with a 19 cm diameter and made of soft and flexible TPE material, ensuring durability and safety during use. The 9 cm hole diameter adds to their functionality, making them easy to store. The bright color of the markers enhances visibility in a range of weather conditions, providing convenience for athletes during training sessions. The set comes with a branded mesh carry bag, keeping the markers organized and easily portable.

ART. 2102005004



## TRAINING SPACE MARKER SET OF 50

The Training Space Marker Set is a versatile set for many kind of sports, includes 50 lightweight markers made of soft, brightly colored plastic. Each marker is 5 cm tall and has an 18 cm diameter at its base. The set contains markers in 5 different colors and comes in a box to prevent any deformation during transportation and storage.

ART. 1805010100



## FLOOR MARKER SET OF 24

The Floor Marker Set of markers is made of durable anti-slip material, making it suitable for use on artificial turf as well as in gym settings. It consists of 24 flat markers in two distinct colors – 12 are yellow and 12 are orange, each with a 15cm diameter. These markers are perfect for agility training, speed drills, and creating clear boundaries or zones during training sessions. They are an essential tool for coaches, and athletes looking for practical and versatile training equipment. For convenient transport, the set includes a metal stand.

ART. 1800002460



## TRAINING SPACE MARKER SET OF 25

The Training Space Marker Set is made of lightweight, brightly colored soft plastic, perfect for young and adult athletes alike. The markers stand 5 cm tall and have an 18 cm diameter at the base. The set includes 25 pieces in 5 different colors and comes with a strap for easy transportation and storage. These markers are ideal for many sports and fun activities and training sessions.

ART. 1802510100



## CUT TOP SPACE MARKER SET OF 50

The Cut Top Space Marker Set of soft plastic markers, designed for a variety of sports training, fitness activities, and more. The markers are 5.5cm high and have a diameter of 18cm at the base. The set includes 50 plastic markers, with each color represented by 10 markers. The set comes with a special stand for convenient organization and storage of the markers. The markers come in 5 different colors, making them perfect for a variety of uses. With its durable construction and specific markers' design with cup top, this set of markers is sure to be a useful addition to any training session or fitness activity with training poles or without them.

ART. 1800012100





## COLOURED CONE CLASSIC

The Coloured Cone Classic is designed to aid in various sport activities and is made of durable PVC with added vinyl. It is suitable for a wide range of exercises commonly used in sports and fitness training. The PVC vinyl step comes in heights ranging from 10cm to 45cm, providing options for diverse workout routines. Its surface ensures safety during use, and its bright colors make it highly visible. It is a lightweight and portable tool, making it convenient for use at home, in the gym, or outdoors.

- ART.  
 1800410500 - 10 CM  
 1806101000 - 15 CM  
 1809101000 - 23 CM  
 1812101000 - 30 CM  
 1801510500 - 38 CM  
 1801810520 - 45 CM



## TRAINING CONES WITH HOLES & SLIT

The Training Cones with Holes & Slit is designed to be versatile and durable for use in agility training, speed drills, and coordination exercises. Made from heavy-duty PVC and featuring 25mm diameter holes, this cone can accommodate flat rings or numbered markers, making it a convenient tool for setting up various drills and activities. Its design allows for separate or simultaneous use with flat rings and poles, providing a wide range of exercise options. Available in two sizes and colors, this cone offers customization for different training needs.

- ART.  
 2006001206 (YELLOW) - 30 CM  
 2006001207 (ORANGE) - 30 CM  
 2006001506 (YELLOW) - 38 CM  
 2006001507 (ORANGE) - 38 CM

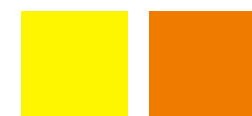

## CONE MARKER WITH HOLES 2.0

The Cone Marker with Holes 2.0 is a valuable tool for sports training, particularly for agility drills and skill development. With its 25mm diameter holes, it allows for versatile placement of slalom poles, making it suitable for a wide range of sports. It is available in vibrant colors, and comes in four different heights (23cm, 30cm, 38cm, and 45cm), providing options for coaches, and athletes to cater to their specific training needs. Overall, this PVC cone with vinyl addition is an essential tool for sports training.

- ART.  
 1800914200 - 23 CM  
 1801214200 - 30 CM  
 1801514200 - 38 CM  
 1801814200 - 45 CM



## CUT TOP SPACE MARKER SET OF 24

The Cut Top Space Markers set is a collection of soft plastic markers, each measuring 7 cm in height and 18 cm in diameter at the base. The set includes 24 units in 3 different colors and comes with a specially designed plastic stand for convenient storage and transport. These markers are ideal for a wide range of sports and training activities with or without slalom poles, providing clear visibility for players. Their lightweight and durable construction makes them suitable for both indoor and outdoor use, perfect for marking training zones and sectors, or creating obstacle courses. The soft plastic material also ensures that they are safe to use and reduces the risk of injury if accidentally stepped on.

- ART. 1800012104





## CONE STRAP

The Cone Strap is a simple yet convenient solution for storing and transporting markers. It can hold 50 to 100 markers at a time, making it ideal for gyms, courts, football pitches or any environment where markers are frequently used. With a length of 100 cm and a width of 3 cm, it provides ample space for hanging and securing the markers. Whether you're on the move or simply looking to keep your markers neatly organized, this marker strap is a practical accessory to have.

ART. 1800122500



## CONE STAND PLASTIC

The Cone Stand Plastic is made of durable plastic and is designed for storing and transporting 40 to 50 cones at a time. It is lightweight, compact, and black in color with a height of 20 cm. Its quite strong construction ensures it can handle regular use, and its convenient size allows for easy storage when not in use. This cone stand is a practical and efficient solution for coaches and athletes to store and transport a large number of cones.

ART. 1800222500



## VELCRO STRAP

The Velcro Strap is high-quality strap, designed for assembling, compactly storing, and transporting training and slalom poles of different diameters, lengths, and designs. It measures 60 cm in length and 2.5 cm in width, making it a simple yet very useful accessory for carrying different poles easily and efficiently.

ART. 1210010200



## POLE CONNECTOR

The Pole Connector is a versatile and durable connector, designed for agility training. This high-strength connector is compatible with both 25mm and 32mm slalom and training poles, providing flexibility for various training needs. The quick and secure attachment system allows for effortless setup and adjustment, perfect for agility drills for many sports indoor and outdoor. This lightweight pole connector is designed for long-lasting use.

ART. 1200161000



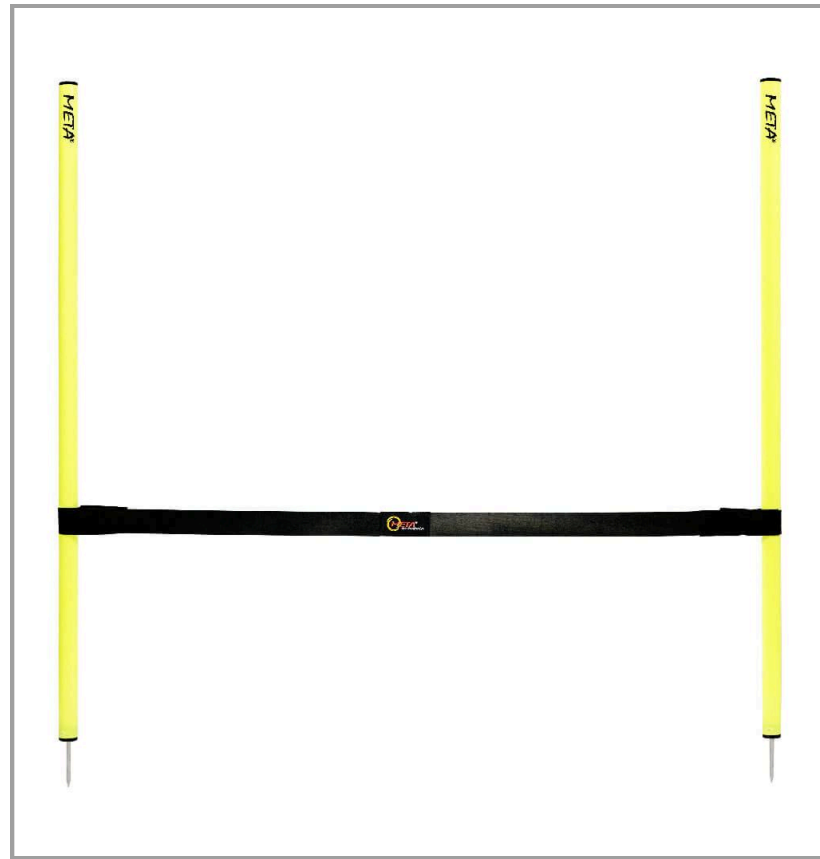

## SLALOM POLES ELASTIC BAND

The Slalom poles Elastic Band is a high-quality product made of rubber. The band can be easily spun with Velcro between 2 slalom poles of any length. Its dimensions are 126 cm in length and 5 cm in width. The band provides resistance and flexibility, allowing athletes to improve their agility, balance, and coordination. Its durable and versatile design makes it suitable for use in both indoor and outdoor training environments. Whether you are a professional athlete or simply looking to improve your fitness and agility, this slalom poles elastic band is an excellent addition to any training regimen.

ART. 1810122500



## MULTI-HEIGHT TRAINING CONE SET OF 20 PCS

The set is essential for any sports training, as it offers a wide range of uses. With a height of 15 cm and a base diameter of 30 cm, these cones feature holes all over their surface, allowing you to create hurdles of different heights and angles using poles for various agility exercises. The set includes 20 cones made of flexible plastic, available in two different colors. In addition, each set comes with a convenient and durable plastic stand that makes transportation and storage easier.

ART. 2002002020



## TRAINING TRIANGLE MARKER SET OF 50

Training Triangle Marker Set of 50 META is ideal for sports training, coordination and speed exercises. Perfect for marking off zones, creating special areas or playing zones in football, athletics, functional training, and other sports.

Key features of the set:

- \* 50 triangular training cones for greater stability
- \* 5 different colours to have more variety for marking off
- \* Flexible and impact-resistant material
- \* Includes a stand for easy transport
- \* Easy for transportation and store
- \* Suitable for indoor and outdoor using

Ideal for coaches, sports schools, academies and athletes of all levels.

ART. 1805025160



GOAL POSTS



## FOOTBALL GOAL POSTS FOLDABLE 90 X 60 CM

These Foldable Football Goal Posts are designed for team training and improving pass and strike accuracy. The hassle-free design allows install them quickly. They are constructed with 38mm metal pipe and high-quality powder coating for durability. The sleek design features a strong polyester mesh net with PU coated fabric trims, and the goal posts come with spikes for added stability. They are available in a size of 90 x 60 cm, making them a practical choice for various training environments.

ART. 2009050150



## POP UP GOAL POST PRO SET OF 2

The Pop Up Goal Post Pro (Red/Black) featuring a durable fiber filament mesh with a geotexite additive, making them perfect for outdoor use. The frame size is 1.6m \* 1m \* 1m, and the set includes special brackets for easy installation on a football pitch. These goals are an excellent choice for football enthusiasts and professionals looking for a combination of quality, practicality and an opportunity to improve their skills of kick and pass accuracy. Its design allows them to fold up. Furthermore, the set comes in a branded stylish bag. These features make them convenient tool for transportation and storage.

ART. 1906100001



## PRO SOCCER GOAL POST

The Pro Soccer Goal Post is a durable and versatile training tool designed for soccer teams to enhance their skills in passing, and shooting accuracy. It is constructed with heavy-duty 38mm steel pipes for long-lasting use and features an easy and fast assembly. The net is made of strong polyester mesh with PVC coated fabric trims and includes hook and loop fasteners for quick and easy fixation. Available in two sizes (2.40 x 1.20m and 1.20 x 0.80m), the Pro Soccer Goal Post is an essential tool to improve players performance on the football pitch.

ART.  
2002450150 - 2,4 X 1,2 M  
2001250150 - 1,2 X 0,8 M



## ALUMINIUM GOAL POSTS FOLDABLE

Aluminium Goal Posts Foldable from META. Lightweight, durable, and easy to install, these goalposts fold completely in just seconds thanks to their locking mechanism. When folded, they are very convenient to transport and store. They feature a reinforced micro-mesh with reliable plastic connectors, ensuring long-lasting durability. Available in two sizes: 120x60 cm and 150x80 cm.

ART.  
2001200060 - 120 X 60 CM  
2001500080 - 150 X 80 CM



DEFENDERS DUMMIES

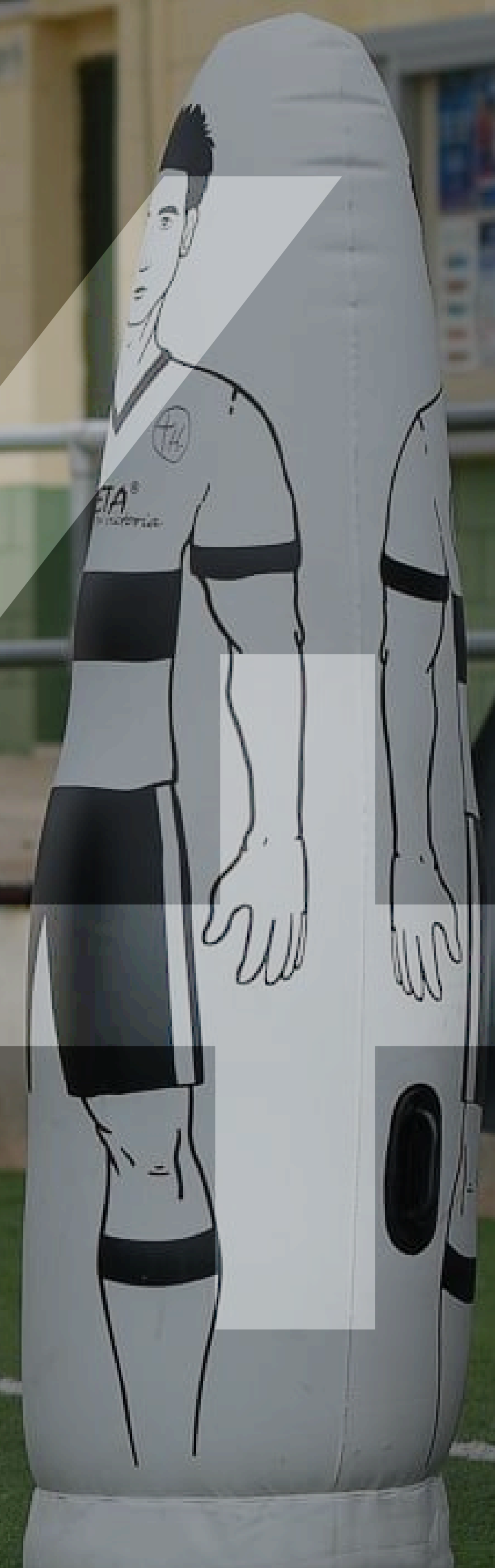



## DEFENDER MAN DUMMY

The Defender Man Dummy is high-strength PVC training dummy, designed to provide stability during intense workouts. It features a durable base with four metal spikes for secure placement on courts or pitches. Standing at 180 (160) cm tall, this dummy is often used by adult athletes. The rugged PVC construction ensures that the dummy can withstand powerful kicks and tackles, making it an excellent training tool for soccer, rugby, handball and other contact sports. It is ideal for a variety of drills, including tackling, dribbling, shooting, headers, and high kicks.



ART. 1501601550 - YELLOW  
1501601551 - RED  
1501601552 - BLUE



ART. 1501801550 - 180 CM



## DEFENDER MAN - DUMMY 125/185 CM

The Defender man - dummy 125/185 cm is made of high-strength PVC tubes and features a plastic cushioning structure at the base. What makes this product unique is its adjustable height, which can be set to three different levels: 125 cm, 155 cm, and 185 cm. As a result, it is suitable for a wide range of exercises and training across various sports. It is especially practical for sports such as football, basketball, handball and futsal. Thanks to its sturdy construction, it can withstand heavy use and provide a stable surface for training. Its adjustable height makes it suitable for users of different ages and skill levels.

ART. 1518516100



## DEFENDER DUMMY RUBBER BASE

The Defender Dummy Rubber Base is designed for installing a defender man dummy on courts, floors, the ground, or a football pitch. It is made of high-strength rubber and weighs 10 kg, providing stability for the dummy. The base has an upper width of 10 cm and features special holes for most metal or plastic defender man dummies. With a length of 48 cm, a lower width of 31 cm, and a height of 11 cm, this base offers ample surface area for installation. Its versatility makes it suitable for various training environments, making it an essential tool for coaches and players looking to improve defensive skills.

ART. 1500000100

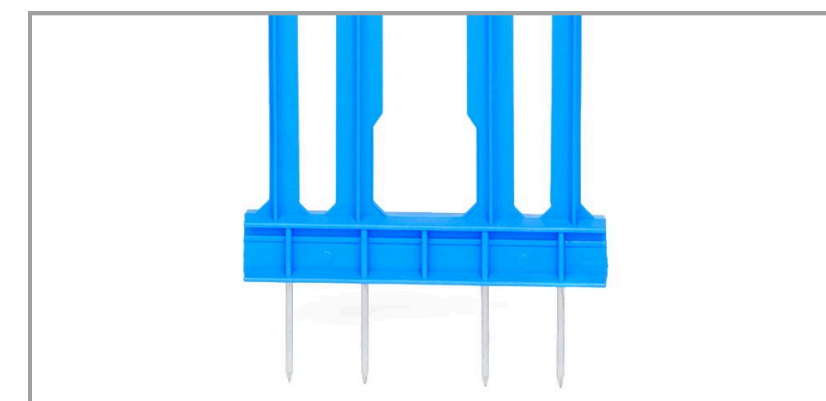
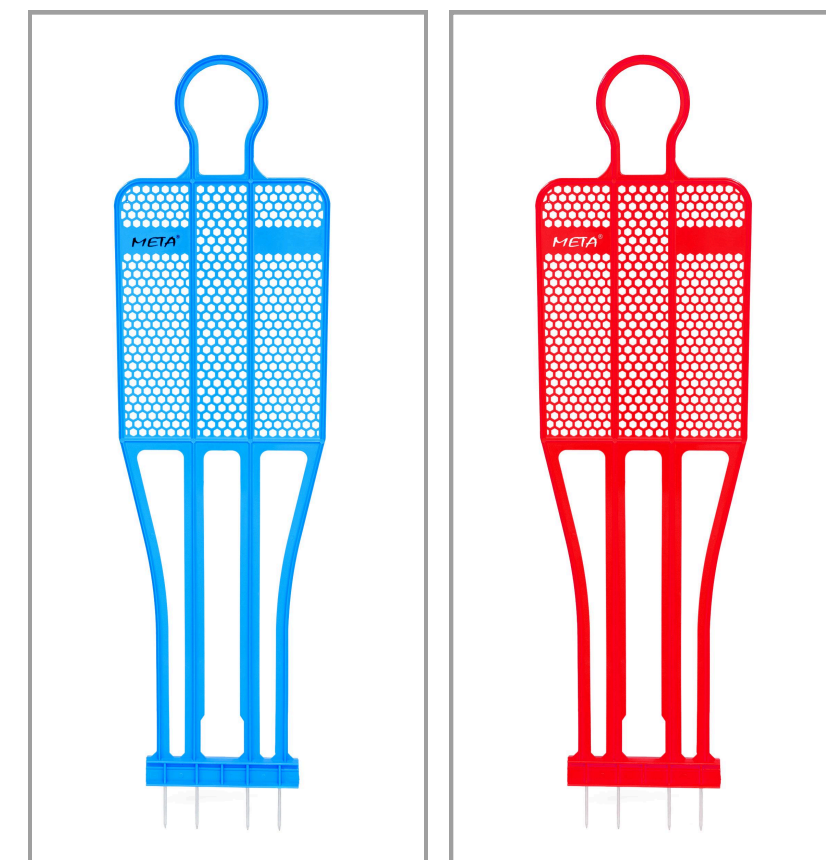

## PRO DEFENDER MAN DUMMY

The Pro Defender Man Dummy is a highly durable training tool made from unbreakable PP (Polypropylene Copolymer). Its design features four metal peaks for securing it to the ground or field, and it can also be used with special rubber bases. This makes it a popular choice for professional teams and adult amateur athletes due to its stability and versatility. Standing at a height of 180 cm, this dummy can be used individually or in conjunction with other similar dummies on specialized carts. It is available in attractive colors. The Pro Defender Man Dummy is a dependable and flexible tool for honing skills and technique.



ART. 3001801552  
3001801553



## INFLATABLE SOCCER DUMMY

The Inflatable Soccer Dummy has a unique pattern and is a highly effective sports equipment made of PVC for football, futsal and handball training, specifically for practicing kicks or throws and improving accuracy. This dummy is available in two sizes: 175 cm height with a 40 cm base diameter, and 205 cm height with a 45 cm base diameter. It is made of 100% elastic rubber, it is durable and able to withstand powerful kicks. It also is waterproof, cold-resistant & UV-resistant 0.6mm. To use it, a customer should fill the base with water and use a special air pump to inflate it. It can be used for individual training or incorporated into team drills. This product provides numerous benefits for players aiming to enhance their skills and reach their full potential. It's important to note that the dummy should not be used in temperatures below 5 degrees Celsius to prevent freezing and potential damage. Product characteristics:

- 1) PVC thickness 0.6mm.
- 2) Cold and UV resistant material.
- 3) High quality spiral valves.
- 4) High quality handles.
- 5) Double layer of material on the base of the product to protect from friction against the surface.
- 6) Printing of the design made with environmentally friendly and non-toxic dyes.

ART.  
2101000175 - 175 CM  
2102000205 - 205 CM

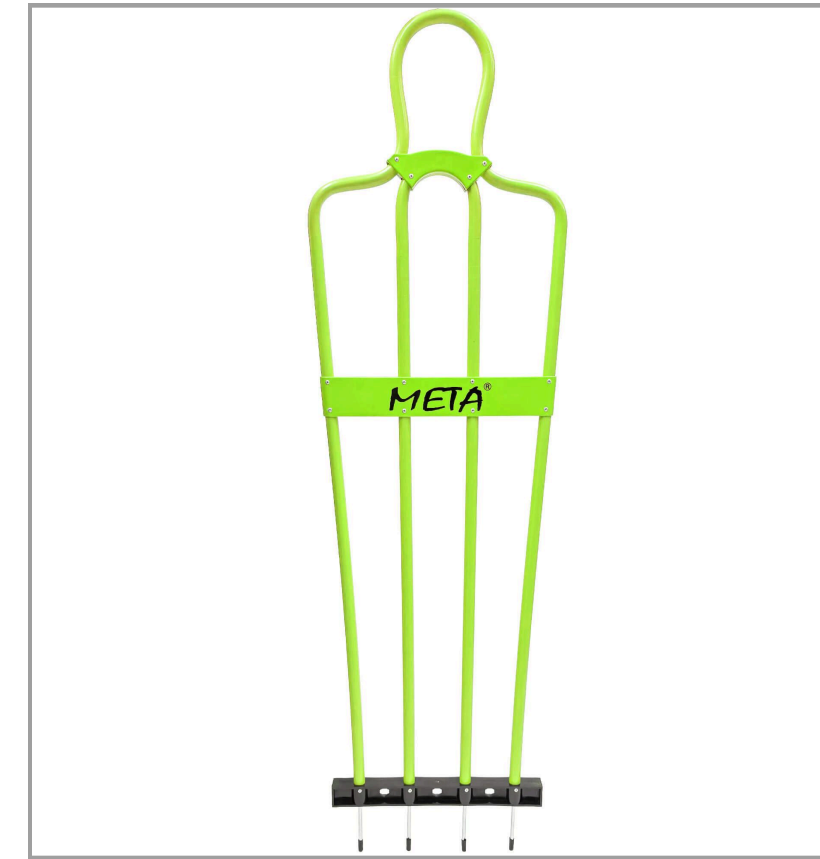

## AIRFLOW DEFENDER DUMMY

The Airflow Defender Dummy 160 cm is perfect training equipment for practicing set pieces and free kicks. These dummies are made of impact-resistant PVC plastic, allowing them to absorb and withstand inaccurate shots. The design provides stability in windy conditions and is easy to use during heavy rain or snowfall.



ART.  
1501600050 - YELLOW  
1501600150 - RED  
1501600250 - BLUE



TRAINING

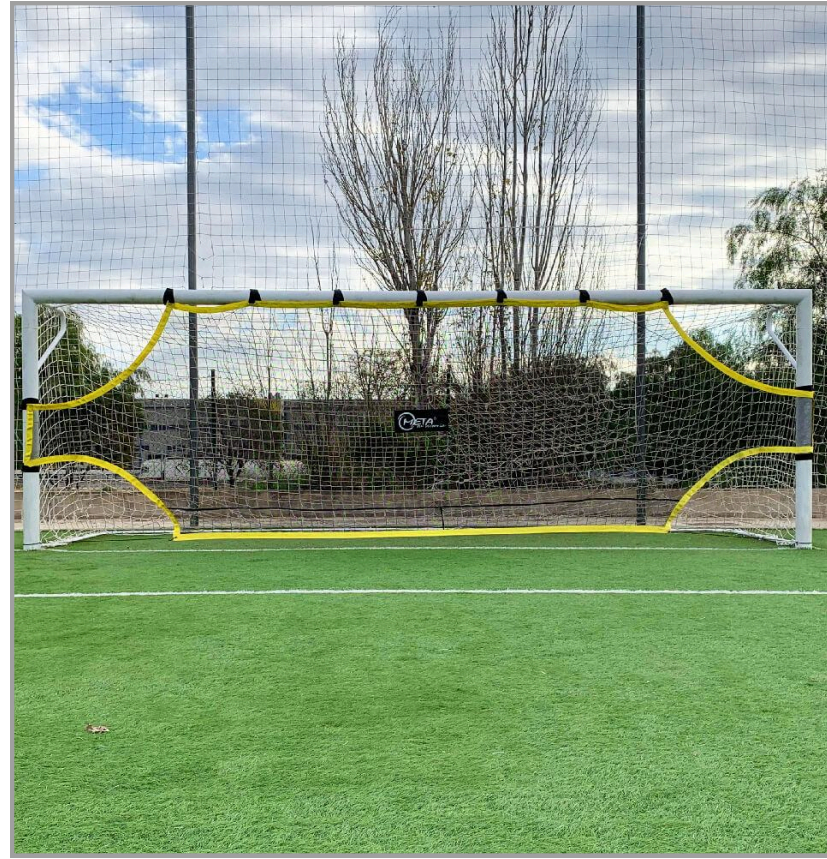

## TARGET SHOT

The Target Shot is a crucial training tool for honing ball shooting skills, suitable for use in soccer practice with or without a goalkeeper. Constructed from heavy-duty mesh and durable polyester fabric, it offers weather-resistant, long-lasting performance. The simple strap attachment allows for easy setup on the goal post. Available in two sizes – 6m x 2m and 7.32m x 2.44m, it comes with a branded bag for convenient storage and portability. This versatile training aid is essential for improving shooting accuracy and precision.

ART.  
2248500510 - 7,32 X 2,44 M  
2052500510 - 6 X 2 M



## FOOTBALL KICK TRAINER

The Football Kick Trainer is a revolutionary tool designed to enhance coordination, passing, reception, and ball delivery skills. This product includes a ball grip belt and a 1.5m latex tube that can stretch up to 6m, all neatly packed in a branded bag for convenience. The adjustable belt is suitable for use with soccer balls of sizes 3, 4, and 5. You can elevate your training sessions and improve your performance on the field with this innovative equipment. It is often used by soccer and volleyball players. Please note that the training machine does not include a ball.

ART. 1500002050



## FLOOR DEFLECTOR FOR GOALKEEPERS

This Floor Deflector for goalkeepers is suitable for training on any surface such as grass, artificial turf (football pitch), or the gym. It helps imitate game's situations with unforeseen ball bounces and trajectory's changes. It is important for increasing some goalkeepers skills.

Main benefits of the META Floor Deflector for goalkeepers:

- \* Simulates unforeseen or random ball's rebounds
- \* Improves decision-making reaction time and keepers speed
- \* Develops catching technique and keepers coordination
- \* Suitable for team trainings and individual sessions
- \* Simple for installation, perfect for outdoor and indoor using

This Floor Deflector for goalkeepers is an excellent addition for football, futsal or handball clubs, academies, or personal training. It will actually raise the keepers skill level of different ages and abilities.

ART. 1901850275

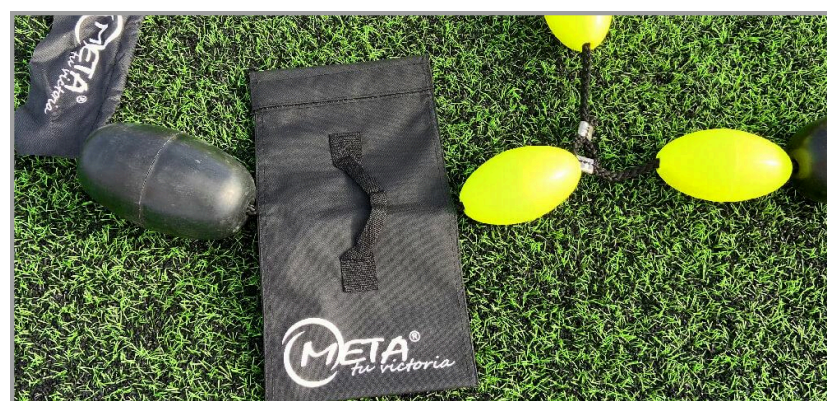

## SOLO KICK TRAINER

The Solo Kick Trainer is designed to improve your ball control, and passing skills. It is made of high-quality neoprene and comes with an adjustable padded waist belt and an elastic cord that stretches up to 5 meters. It is suitable for soccer ball sizes 3, 4, and 5 and comes in a branded bag. Please note that a ball is not included. This product is an important tool for soccer and volleyball training.

ART. 2500002050



## SOCCKER PASSING ARC ROUND

The Soccer Passing Arc Round is high-strength PVC tube arc structure with spikes at both ends is a valuable tool for training passing and ball control in team sports. It comes in two sizes, 30 \* 45 cm and 38 \* 45 cm, catering to different training needs. Its adjustable design allows for versatile use in solo or team practice. The arc structure helps improve passing accuracy and ball control, making it an essential training aid for players of all skill levels.

ART.  
1512180120 – 30X45 CM  
1515180120 – 38X45 CM

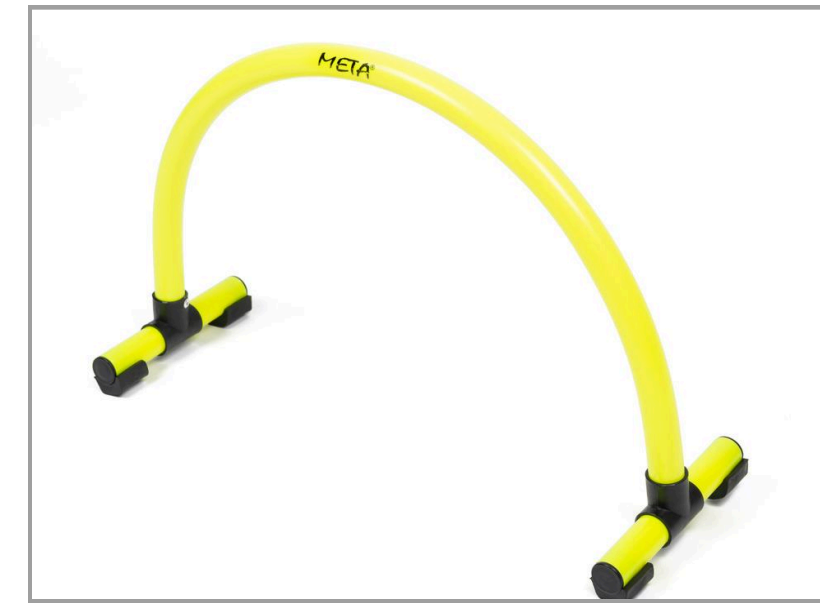

## INDOOR PASSING ARC

The Indoor Passing Arc is designed to improve passing and ball control skills for various sports. It features a durable PVC tube structure with plastic sled legs, making it suitable for both indoor and outdoor use. Measuring 30 \* 45 cm and 38 \* 45 cm, it can be easily incorporated into individual training sessions or team drills. This passing and ball control training equipment offers durability, versatility, and convenience, making it an essential addition to training regimens for football, futsal and other ball sports.

ART.  
1512182120 – ROUND 30X45  
1515182120 – SQUARE 38X45



## SOCCKER PASSING ARC SQUARE

The Soccer Passing Arc Square is a highly effective training aid for honing passing and ball control skills. This arc structure is crafted from durable, high-strength PVC tubes and features spikes at both ends for secure placement. Available in two sizes (30 \* 45 cm and 38 \* 45 cm), this versatile tool caters to various training requirements. Its lightweight design ensures easy portability, making it suitable for individual and team workouts in football, futsal, or handball. This arc is a valuable asset for coaches and athletes seeking to enhance passing accuracy and ball control abilities.

ART.  
1515181120 - 38X45  
1512181120 - 30X45

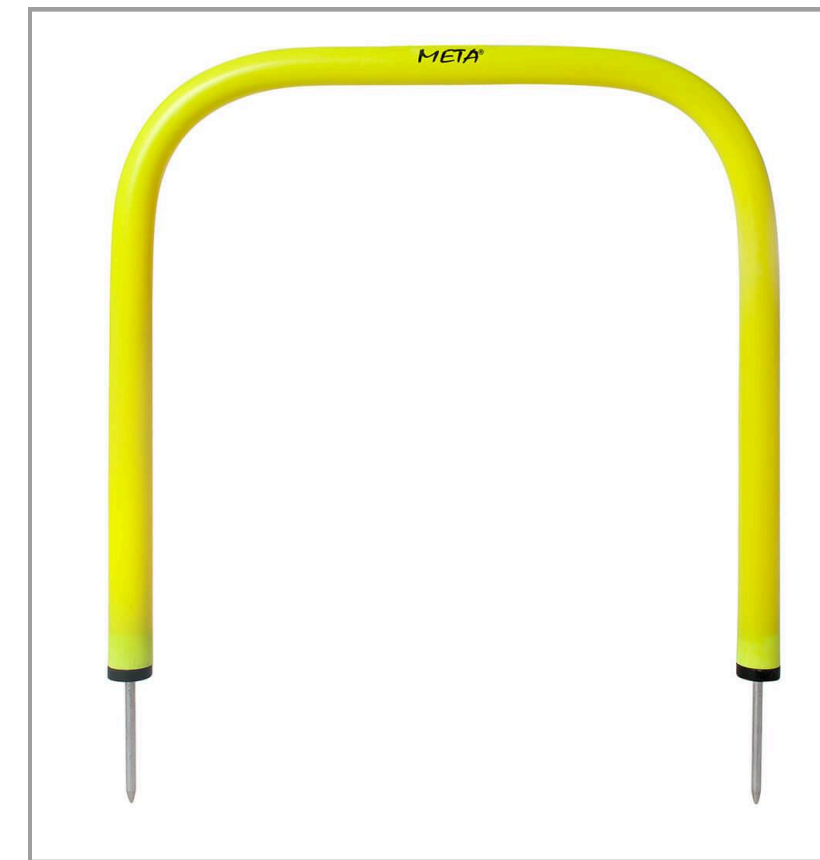

## SQUARE PASSING ARC PRO 45\*45 CM

The set of non-slip flat markers with holes. The ring design of these markers allows to collect them onto an arm fast and easily. You can store about 50 pcs on your arm simultaneously, saving the time when setting up and putting away trainings. They are non-marking and can be used on a whole range of surfaces, no matter where you play or workout. The markers come in a bright colour to help athletes spot them in all weather conditions. This set includes 10 pcs of these markers. Each of markers has a diameter of 19 cm, made up of TPE material that make them very soft and flexible. The hole diameter is 9 cm. The set comes in a mesh branded carry bag.

ART. 1615181120



## SOCCKER TENNIS NET SET 3X1 M

The Soccer Tennis Net Set 3m x 1m is great for improving gaming skills and can be used for warm-up exercises. It's equipped with long legs, making it easy to use in gyms and outdoor spaces. The product is compact and fully foldable, and it comes with a branded bag for convenient transportation. The dimensions of the play net are 3m long and 1m wide, and the portable net stands at 110cm high. With its versatile design and features, it's an excellent choice for anyone looking to enhance their gaming abilities.

ART. 1500312850



## SOCCKER TENNIS NET SET 6X1 M

The Soccer Tennis Net Set 6 mtr x 1 mtr is ideal for warming up and honing gaming skills. It comes with special long legs for easy use in the gyms and outdoor settings. It is compact and fully foldable, and includes a convenient branded bag for effortless transportation. The set measures 6m in length and 1m in width. The product's versatility, portability, and durability make it a valuable addition to any workout routine, and it is suitable for both individual and group training sessions, indoors or outdoors.

ART. 1500612850

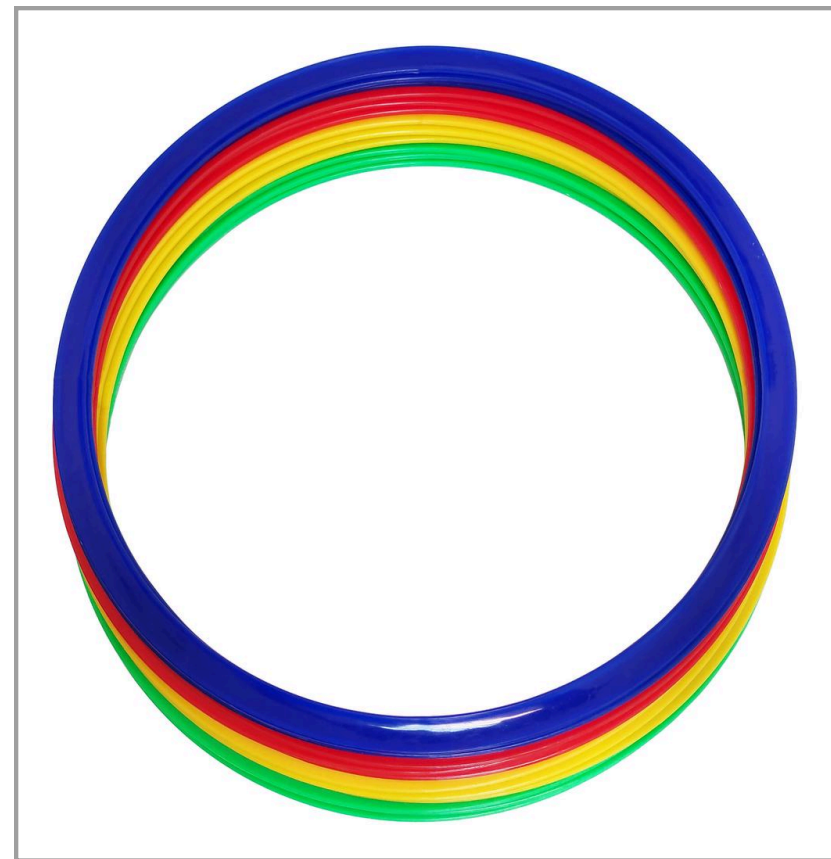

## FLAT AGILITY RINGS SET OF 12

The Flat Agility Rings is a set of 12 agility rings in four different colors, designed for improving speed and agility. The rings feature a simple and seamless design, making them suitable for various indoor and outdoor exercises. The set comes in a branded bag for easy storage and transportation convenience. The sets of the rings are available with diameters of 40, 45, and 60 cm, they are perfect for all skill levels and can be used for different training exercises. These agility rings are widely used in sports training, fitness classes, and physical therapy sessions.

ART.  
1500160450 – 40 CM  
1501804108 – 45 CM  
1500240450 – 60 CM

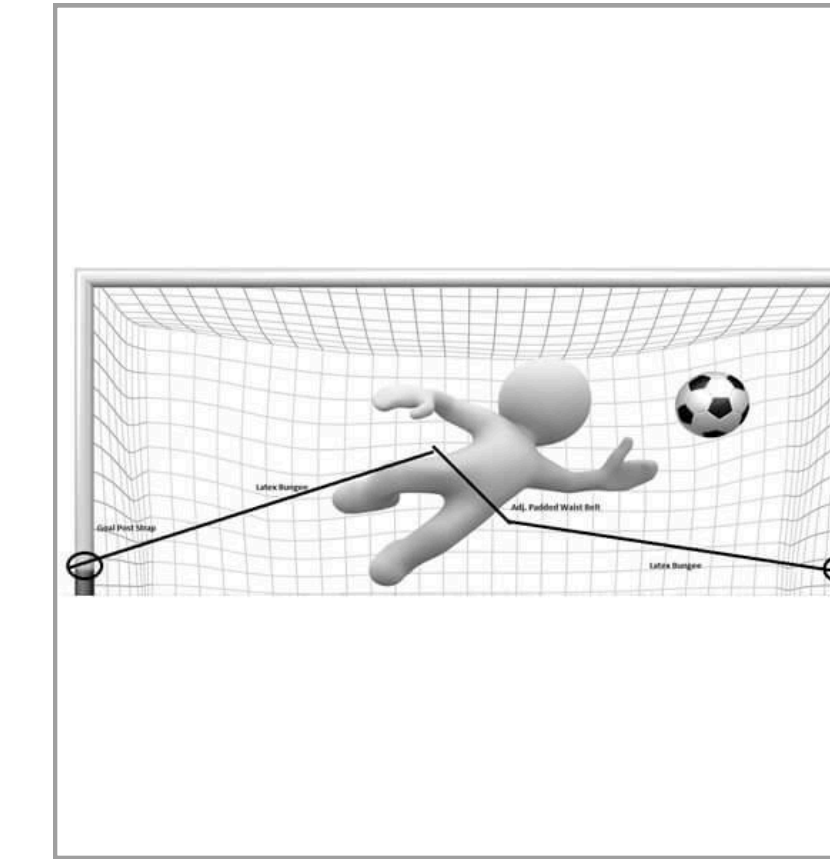

## FOOTBALL GOALKEEPER HARNESS

The Football Goalkeeper Harness is a specifically designed training tool for goalkeepers to improve their defense skills, reflexes, and agility. It includes a padded waist harness with a 10cm width, heavy-duty 2 latex bungees covered with sleeves, each 2 meters in length for connecting to goal posts, and heavy-duty straps to secure it in place. This equipment comes with a branded carry bag for convenient transportation. It is an essential tool for goalkeepers aiming to enhance their skills and overall performance.

ART. 2001460154



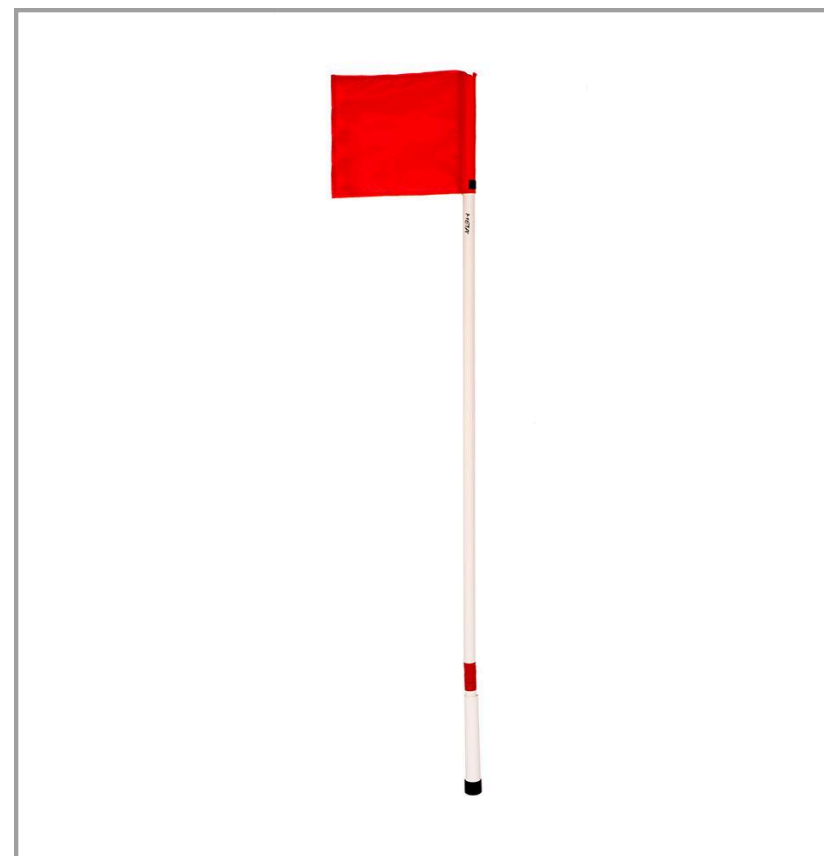

## SET OF 4 CORNER FLAGS FLEXI RACER

The Set of 4 Corner Flags Flexi Racer designed for football matches, built to UEFA standards and suitable for both official and unofficial games. The set includes sturdy plastic tube poles with special brackets for easy installation on bases. The 30mm diameter poles and 1.5m height ensure excellent visibility on the pitch. Crafted from durable and highly flexible materials, these flags offer longevity and reliability. Overall, the Set of 4 Corner Flags Flexi Racer provides a practical and reliable solution for football pitches, offering clear visibility and ease of use for referees and players alike.

ART. 1943210100



## TRAINING BIB

The training bib is crafted from high-quality, breathable fabric, ensuring practicality and comfort during use. With a clean trim on the collar and shoulders, it combines functionality with an attractive design. Available in sizes S, M, L, and XL, for both men and women, it is suitable for use by athletes of all ages. Thanks to its durable material and easy maintenance, it is suitable for frequent training sessions or matches. S: 5-8 years; M: 9-12 years; L: 13-16 years old; XL: over 16 years old.

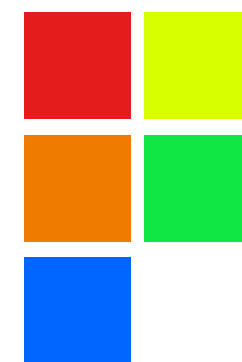

ART.  
1900101005 – SMALL  
1900111005 – MEDIUM  
1900121005 – LARGE  
1900131005 – XL

ART.  
1900101003 – SMALL  
1900111003 – MEDIUM  
1900121003 – LARGE  
1900131003 – XL



ART.  
1900101002 – SMALL  
1900111002 – MEDIUM  
1900121002 – LARGE  
1900131002 – XL

ART.  
1900101004 – SMALL  
1900111004 – MEDIUM  
1900121004 – LARGE  
1900131004 – XL

ART.  
1900101006 – SMALL  
1900111006 – MEDIUM  
1900121006 – LARGE  
1900131006 – XL

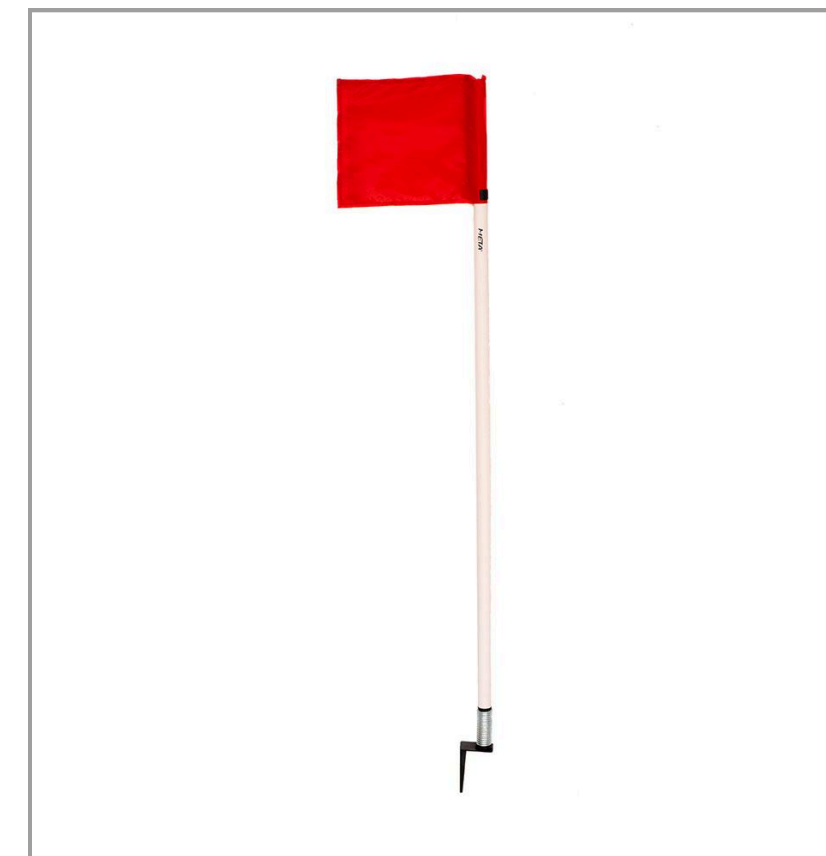

## SET OF 4 CORNER FLAGS FLEXI PRO

The Set of 4 Corner Flags Flexi Pro is designed for use on the pitch. The flags feature durable flagpoles with a 32 mm diameter and a height of 1.5 m. Each flag includes a steel shock-absorbing structure at the bottom, which is coated with a rust-resistant powder coating. The flags also come with spits for easy insertion into the ground, ensuring stability during game play. Constructed from a flexible yet strong material, these flags can withstand the demands of football matches and remain highly visible. Overall, the Set of 4 Corner Flags Flexi Pro provides a practical and reliable solution for football pitches, offering clear visibility and ease of use for referees and players alike.

ART. 1943212100



## TRAINING BIB REVERSIBLE

The training bib is crafted from high-quality, breathable fabric, ensuring practicality and comfort during use. Thanks to its design, both sides of the bib can be used, which is very important and comfortable during team training. With a clean trim on the collar and shoulders, it combines functionality with an attractive design. Available in sizes S, M, L, and XL, for both men and women, it is suitable for use by athletes of all ages. Thanks to its durable material and easy maintenance, it is suitable for frequent training sessions or matches. S: 5-8 years; M: 9-12 years; L: 13-16 years old; XL: over 16 years old.



ART.  
2900101000 – SMALL  
2900111000 – MEDIUM  
2900121000 – LARGE  
2900131000 – XL

ART.  
2900101001 – SMALL  
2900111001 – MEDIUM  
2900121001 – LARGE  
2900131001 – XL



REBOUNDERS

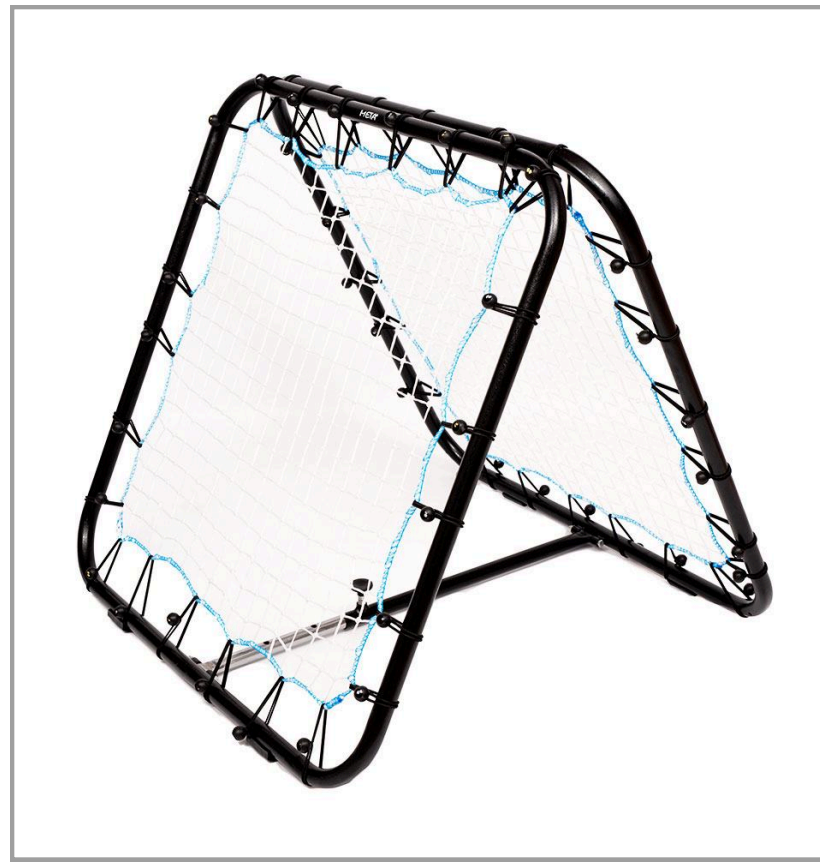

## DUAL REBOUNDER ELITE

The Dual Rebounder Elite is a high-strength 32mm steel tube rebounder with a powder protective coating, which enhances its durability. Its design allows for five adjustable angles of inclination, providing versatility for various workout sessions. Each side of the rebounder is 1m x 1m and features nets with different tension levels. The base of the rebounder is equipped with rubber pads to prevent slipping on any surface. This rebounder offers stability, durability, and versatility for a wide range of workout routines.

ART. 1500112130



## DUAL REBOUNDER ELITE WITH BLACK FABRIC

The Dual Rebounder Elite with black fabric is a versatile and durable equipment. Its ability to adjust to six different angles of inclination makes it ideal for varying workout sessions. One of the sides of the rebounder is made with heavy-duty fabric, making it suitable for use with various types and sizes of balls. This feature adds a lot of versatility to the product, allowing for a wider range of training regimes. Constructed from high-strength 32mm steel tube and featuring a 1m x 1m size, the rebounder is built to withstand intense workouts and heavy use. The protective coating adds an extra layer of durability, ensuring that the product will last for a long time. The non-slip rubber pads make it safe to use on any surface, reducing the risk of slipping or accidents during workouts. Additionally, the foldable design makes it easy to store and transport.

ART. 2000300130



## THREE-SIDED REBOUNDER ELITE

The Three-Sided Rebounder Elite is innovative sports rebounder features a sturdy 32mm steel tube design with powder coating for enhanced durability. With three 1m x 1m sides, each equipped with a different tension net, it allows for simultaneous training on multiple sides. The fully assembled and compact design makes it easy to transport and store, while the rubber pads on the base provide stability on any surface. Ideal for many team sports training, this versatile and durable rebounder is an essential tool for athletes at all levels.

ART. 1500013230



## ONE-SIDE REBOUNDER ELITE

The One-side Rebounder Elite is constructed with 32mm steel tubing and a protective powder coating for enhanced durability and rust resistance. Its adjustable design allows for different workout angles, and it includes a 1m\*1m durable net on one side. The base is equipped with rubber pads to prevent slipping on various surfaces. Its robust and portable design makes it suitable for both indoor and outdoor use, and it is easy to assemble. This rebounder offers stability, versatility, and convenience during training sessions.

ART. 1500112131



## REBOUND BOARD 120 X 60 CM

The Rebound Board is an essential piece of equipment for soccer players looking to improve their skills. Designed for both professionals and amateurs, this high-quality board is made of impact-resistant polypropylene composite material, ensuring durability and weather resistance. It can be used at two different angles and features foldable legs and special holes for convenient transportation. With dimensions of 120x60 cm and weighing 16 kg, the Rebound Board is compact and portable, suitable for use on soccer fields or courts. Its black color makes it stand out, and its simple installation and usage make it a convenient and effective training tool for players aiming to take their skills to the next level.

ART. 1901200160

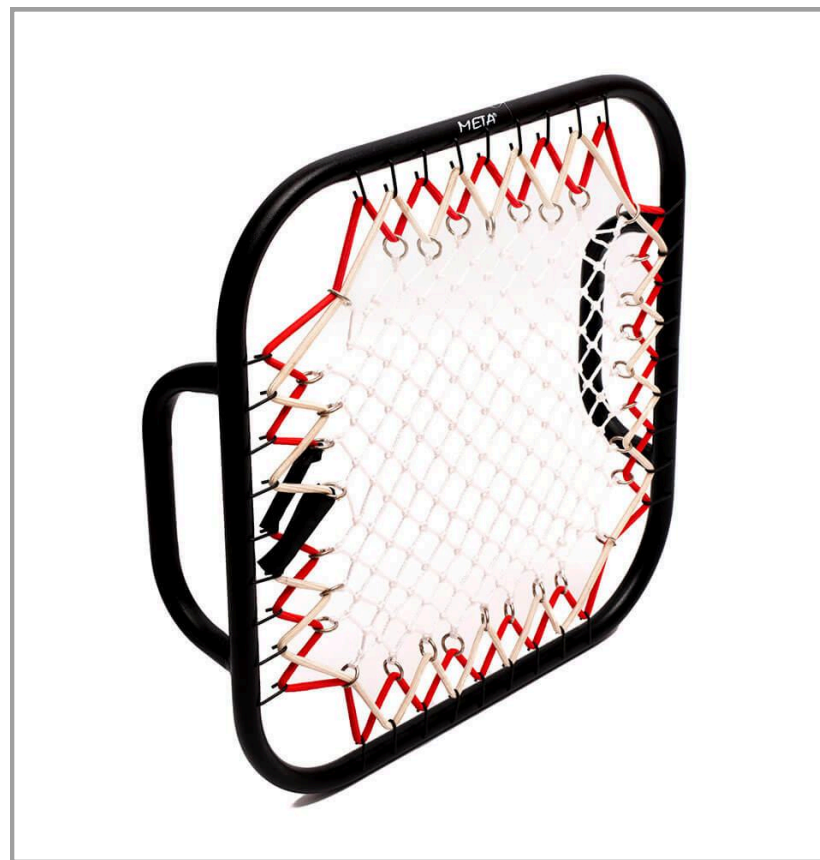

## GOALKEEPER REBOUNDER ELITE

The Goalkeeper Rebounder Elite is a must-have for goalkeeper training, this rebounder boasts a sturdy metal frame with a powder coating and a robust net made of wear-resistant fabric. With two handles for a better grip, it allows for adjustable angles to vary training exercises. At a convenient size of 60\*60 cm, this rebounder is perfect for honing goalkeeping skills during training sessions. Improve reflexes, handling, and versatility with this durable and reliable goalkeeper training rebounder, ideal for simulating game scenarios and enhancing performance on the field.

ART. 1500242230

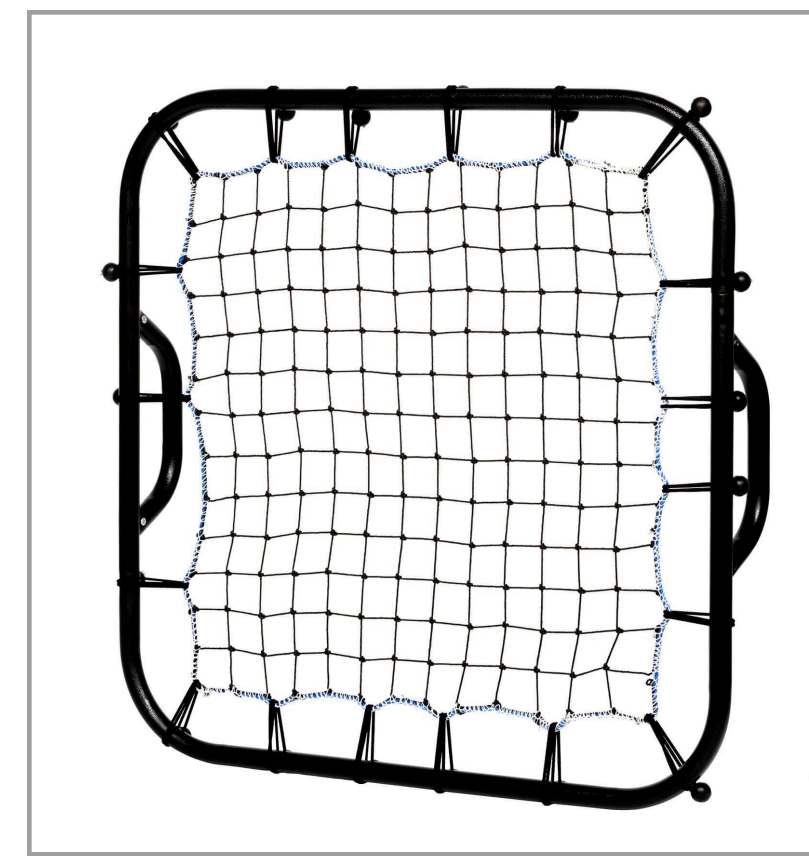

## COLLAPSIBLE MINI GOAL KEEPER REBOUNDER

The Collapsible Goalkeeper Rebounder is designed to help improve goalkeepers playing skills. It features a sturdy metal construction with a net and a powder-coated finish, ensuring long-lasting performance. The rebounder's fully collapsible design allows for easy transportation and storage, making it a practical training tool for athletes. With two handles for a secure grip and adjustable angles, it offers versatility and customization in training sessions. Measuring 80 cm \* 80 cm, it is deal for football goalkeepers and other athletes who are going to enhance hands strength and reaction.

ART. 2000250235

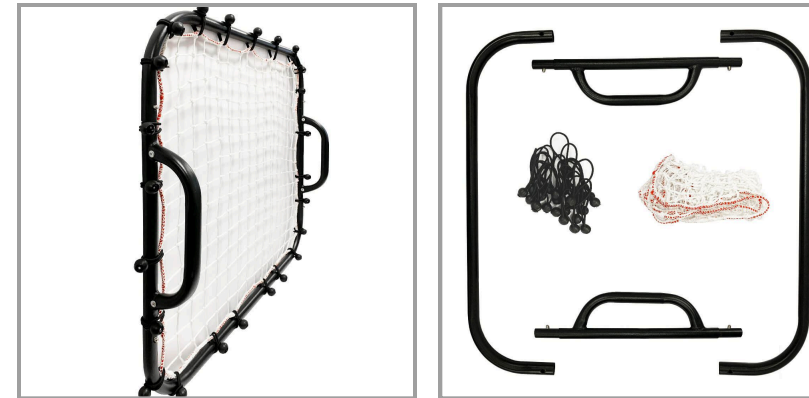

## ONE-SIDE REBOUNDER

The One-side Rebounder is constructed with 25mm steel tubing and features a protective powder coating, making it highly durable. It offers adjustable angles of inclination for versatile training. The functional design includes a 1m x 1m surface area and a sturdy net. The base is equipped with rubber pads to prevent slippage on various surfaces. The rebounder is easy to assemble and disassemble for convenient storage and transport, making it suitable for a range of sports training such as soccer, basketball, and handball. This kind of rebounder provides durability, functionality, and flexibility for athletes of all skill levels.

ART. 1500112132



## FOOTBALL REBOUNDER GOAL 100 X 40 CM

The Football Rebounder Goal has dual-purpose use: depending on its position on the ground, it can be used as a rebounder or as a mini goal. It is foldable and assembles quickly, making it very convenient for transport and storage. This product is equipped with reinforced safety hinges and a locking system. It is usually used for various types of ball training.

ART. 1900010040



GYM



## SPEED CHUTE

The Speed Chute is an essential tool for training speed, sprinting, and endurance, and can be used without a partner. Simply attach the parachute belt to your waist and start your running exercises. It comes in a stylish and compact branded bag for convenient storage and transportation. Available in various sizes including 102 cm, 122 cm, 143 cm, and 183 cm, this parachute provides resistance while running to improve speed and stamina. The adjustable belt allows for a comfortable and secure fit for users of all sizes. Its compact and portable design makes it easy to take with you to the gym or training field. Overall, this parachute is a must-have for anyone looking to enhance their running performance.

- ART.  
 1400400170 – 102 CM (SMALL)  
 1400480170 – 122 CM (MEDIUM)  
 1400560160 – 143 CM (LARGE)  
 1400560150 – 183 CM (XL)

## SHOULDER RESISTANCE HARNESS

The Shoulder Resistance Harness is an essential tool for improving endurance and resistance, this durable nylon harness with soft shoulder straps is ideal for athletes, fitness enthusiasts, and anyone focused on strength and stamina. The 3m-long latex tube provides ample resistance, and the handle allows partners to adjust tension during workouts. The easily adjustable harness fits a wide range of sizes, and is perfect for resistance training with a partner. After use, the harness can be conveniently stored in its branded bag.

ART. 1400000150



## PRO HOME GYM SUSPENSION TRAINER

The Pro Home Gym Suspension Trainer is a form of suspension training that uses body weight exercises to develop strength, balance, flexibility, and core stability simultaneously. It is made up of heavy duty nylon belt with high-quality metal buckles, carabiners, and very strongly stitched and designed for bearing a complete body weight. A customer can adjust the straps for himself. The Pro Home Gym Suspension Trainer allows for a wide variety of exercises, including push-ups, planks, squats, lunges, and more, making it a versatile and efficient workout tool. The product can be used at home, in the gym, or even outdoors, providing a convenient and effective way to stay in shape. The product comes with a specific door anchor in a branded carry bag.

ART. 2000502502



## STRETCHING-FITNESS MAT

The Stretching-Fitness Mat is perfect for outdoor warm-up, yoga, and Pilates sessions. Made of durable polyester fabric, it features a padded surface for added comfort during physical activities. Measuring 180 cm \* 60 cm \* 1.2 cm, the mat is filled with a 10 mm EP sheet for stability. Its design makes it easy to fold for storage and transport, and it comes with a branded carry bag for added convenience. This mat is perfect for all kinds of outdoor workouts.

ART. 2000501005



## FOLDING MAT

The Folding Mat is a versatile exercise accessory designed for use both indoors and outdoors. It is ideal for yoga, pilates, stretching, and other floor exercises. Constructed with durable vinyl fabric and a foam sheet interior, this mat provides a comfortable and non-slip surface for added stability during workouts. Its folding design allows for easy storage and transportation, while the carry handle makes it convenient to take with you on the go. Measuring 180 cm \* 60 cm \* 4 cm, the Folding Mat offers ample space for various exercises.

ART. 2000501004



## AEROBIC STEP PLATFORM

The Aerobic Step Platform is a versatile fitness tool suitable for aerobic training, cardio exercises, and strength workouts. It enables users to perform a wide range of exercises including planks, crossovers, jumps, lunges, push-ups, and more, making it a multifunctional piece of equipment. Additionally, it features a non-slip surface and 4 rubber feet for stability and can support loads of up to 120 kg. With an adjustable height ranging from 10 to 15 cm, it caters to users of varying fitness levels. Its compact and lightweight design (68 x 28 x 10 cm, 2.5 kg) makes it convenient for storage and transportation.

ART. 1600002101





## SOFT PLYO BOX SET

The Soft Plyo Box Set is a versatile and essential tool for jump training, specifically designed to build leg power and improve explosive performance. This set consists of four plyo boxes of varying heights and colours (15cm, 30cm, 45cm, and 60cm), all constructed with heavy-duty vinyl fabric and packed with high-density EVA sheet for durability and safety. Each box features Velcro straps for secure stacking and connectivity, ensuring stability during intense workouts. Suitable for athletes, fitness enthusiasts, and individuals seeking to enhance their lower body strength and agility, these soft plyo boxes provide a safe platform for plyometric exercises such as box jumps and depth jumps, facilitating improvements in vertical jump and speed. Whether used in home conditions, the gyms, or professional training facilities, this set offers a reliable and effective solution for improving overall athletic performance.

ART. 2006121824



## METAL PLYO BOX SET

The Metal Plyo Box Set is designed to help athletes improve their speed, power, and vertical jump. Whether you're a professional athlete or a fitness enthusiast, these metal plyo boxes are an ideal training tool. Each box is made of heavy-duty steel and has a non-slip top surface for safety. The set includes three boxes of different heights (30 cm, 45 cm, and 60 cm) that can be stacked for easy storage and transportation.

ART. 2012182400



## 3 IN 1 SOFT PLYO BOX

The 3 In 1 Soft Plyo Box is an equipment for plyometrics, also known as jump training. It is a type of exercise aimed at increasing muscle power and speed-strength through explosive movements. It is focused on rapidly transitioning from muscle extension to contraction through various jumping exercises. The 3 In 1 Soft Plyo Box offers three height options (51 cm, 61 cm, and 75 cm), constructed with heavy fabric and EP foam sheeting for durability and stability. It is important to use proper form and technique to minimize the risk of injury, as plyometric training can put strain on joints. Incorporating plyometrics into a training program can be beneficial for improving explosive power and agility.

ART. 2000303001



## FITNESS BALL

The Fitness Ball comes in two sizes, with diameters of 65 and 75 cm, and is made of durable PVC. It is a versatile tool ideal for home workouts, warm-up routines, and rehabilitation exercises, and effectively helps relieve tension from the lumbar region, strengthen back muscles, and other muscle groups. The Anti-Burst system ensures the ball is durable and safe to use, providing peace of mind during workouts. The anti-slip surface properties ensure stability and prevent accidents while exercising. With a maximum load of 150 kg, this Fitness Ball can accommodate users of different ages and body types, making it suitable for a wide range of people.

ART.  
1700000065 - 65 CM  
1700000075 - 75 CM



## BOSU BALL

The Bosu ball is a versatile piece of fitness equipment designed for balance training, core strengthening, and overall body conditioning. Its unique design allows for a wide range of exercises, making it a valuable addition to any workout routine. It consists of a solid base made of impact-resistant technical thermoplastic resin (ABS) and a durable PVC hemisphere that can be inflated or deflated to adjust its hardness. The Bosu ball can withstand loads of up to 300 kg and its 60 cm diameter and 22 cm height make it suitable for various workout environments such as gyms, rehabilitation centers, or home use. It is commonly used by athletes, fitness enthusiasts, and in physical therapy settings to improve balance, stability, and overall physical fitness.



ART. 1600002103

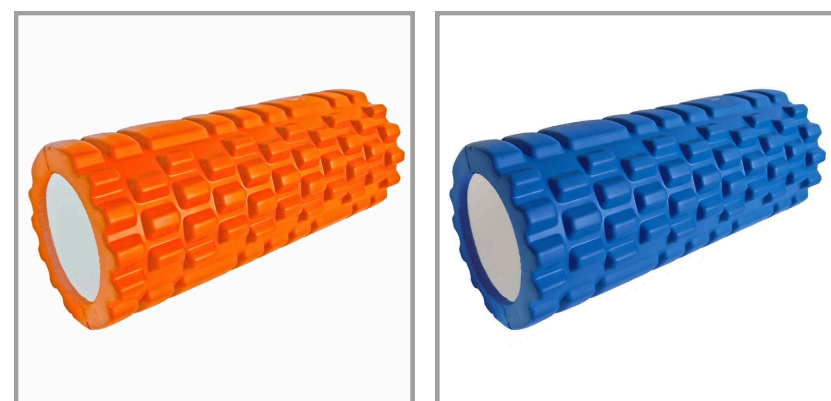

## MASSAGE ROLLER

The massage roller is soft-touch, textured foam roller is used for flexibility, strength and recovery support. It is made of 45% EVA closed cell foam over 55% plastic molded core for long-lasting support. Its training focus is on rehabilitation, pilates, yoga, different sports, etc. The roller is an ideal product for a massage and strengthening of the deep muscles. Athletes use it to target tired and sore muscle areas with varied pattern design for deep self-massage. The rollers have different lengths of 33 and 45 cm, but similar diameter of 14 cm.



		
ART. 1710000033 - 33 CM 1710000045 - 45 CM	1710000033 - 33 CM	1720000045 - 45 CM

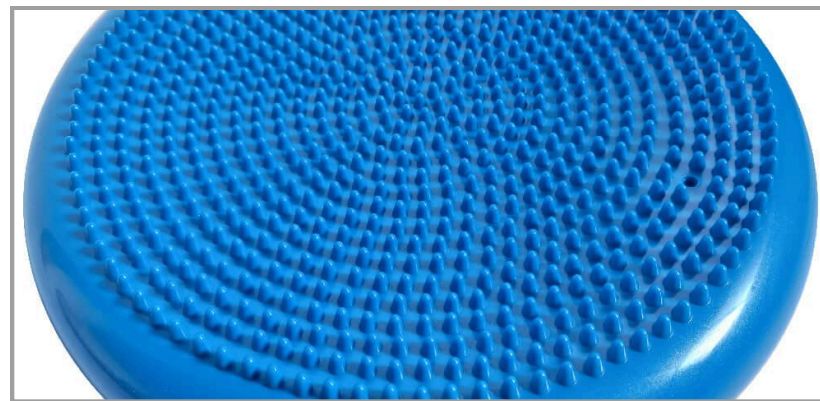

## BALANCE CUSHION

The Balance Cushion is a versatile piece of sports equipment. The product is ideal for strengthening the vestibular apparatus, improving dexterity, flexibility, coordination and can serve as a seat cushion for improving posture and core strength, provides a therapeutic feet and palm massage and can be used for stress relief. Suitable for both adults and children. Made of high-quality durable PVC, it features a non-slip surface and has a diameter of 33 cm and a height of 9 cm.

ART. 1600002102



## BALANCE BOARD

The Balance Board, made of high-strength plastic, is designed for user balance training and rehabilitation after potential injuries. With a diameter of 41.5 cm and a platform height of 5 cm, it caters to both amateur athletes and professionals. Its non-slip surface ensures safety during use, and its compact size allows for easy storage and portability. Suitable for improving coordination, stability, and core strength, this versatile balance board is a valuable tool for a wide range of users. Ideal for a variety of exercises, including squats, lunges, and planks, it helps target different muscle groups and enhance overall balance and stability.

ART. 1600002100

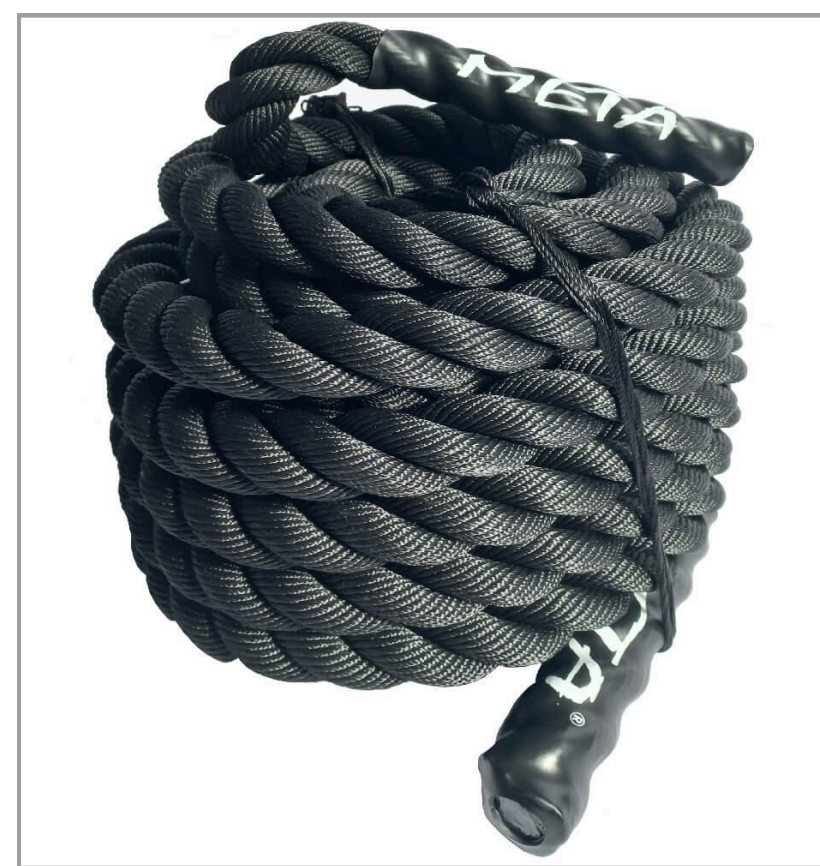

## POWER ROPE

A Power Rope is a training rope of high quality. The balancing rope is robust and has a non-slip surface for better gripping. It is designed for "wave-based" functions. The rope helps with effective physical preparation, resistance and coordination. This rope also is useful for practice balancing and it also promotes motoric skills. This kind of power rope is suitable for amateurs and professional athletes. The Rope diameter is 38 mm and 12 mtr of length. It has a black colour.

ART. 2000501001



## REACTION BALL 10 CM

1. The Reaction Ball is a specially designed fancy-shaped ball is perfect for agility and hand-eye coordination training for athletes in sports such as basketball, soccer, and tennis. Made of secondary foaming rubber and is available in various colors. Its unique design provides unpredictable deflection, making it an ideal tool for reaction and visual-motor coordination development. The ball's durability and grip make it suitable for intense training sessions.



ART.  
1601001200  
1601001201  
1601001202



## ELASTIC BANDS SET OF 3 PCS

The Elastic bands Set includes 3 high-quality natural latex bands with varying levels of resistance, making it easy to adjust the intensity of your workout. The color-coded bands indicate the different resistance levels, and the durable material ensures long-lasting use. With a circumference of 60 cm and a width of 5 cm, these bands are suitable for a wide range of training exercises targeting the buttocks, legs, arms, and back. Whether you're a beginner or an advanced athlete, this versatile set is a perfect tool for a user.

ART. 4003000500



## ELASTIC POWER BAND

The Elastic Power Band is a versatile exercise product designed to provide resistance for general exercises, rehabilitation, and can be used as a supplementary tool for aerobic training. Its high-quality construction and durability ensure a safe and effective training experience. It is conveniently portable, making it easy to fold up and take to the gym, a court, or outdoors for workout sessions. The different band sizes cater to various levels of resistance, with each level denoted by a specific color and width. Each one has a different width and a colour depending on level of resistance: light/2,9 cm/purple; medium/4,5 cm/green; heavy/6,4 cm/blue; x-heavy/8,3 cm/orange. The Elastic Power Band is also suitable for home use and can assist in learning exercises such as pull-ups. With a similar loop length (208 cm), they are a practical and adaptable fitness accessory for individuals at any fitness level.

ART.  
4003000501 - LIGHT  
4003000502 - MEDIUM  
4003000503 - HEAVY  
4003000504 - X-HEAVY



REFEREE



## REFEREE WARNING CARDS KIT

The Referee Warning Cards Kit includes two warning cards (yellow and red) for issuing warnings to match participants, a pencil, and sheets for note-taking. It is compact, with the folded cover measuring 16 \* 10 \* 1 cm. The entire set comes in a tidy notebook, making it convenient for referees officiating in various sports.

ART. 1900003200

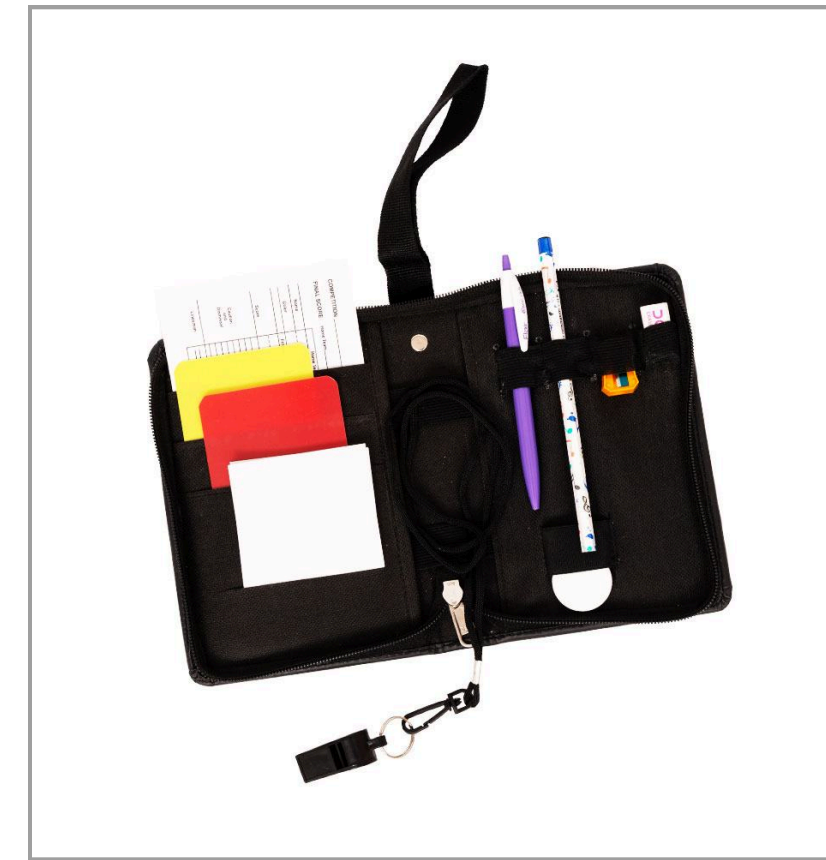

## REFEREE DATA WALLET

The Referee Data Wallet, a vital tool for match officials. This compact wallet includes a closure and is equipped with two warning cards (yellow and red), note sheets, a pencil, a pen, a whistle with a string, an eraser, and a special coin for the traditional match start. Measuring at 14.5 x 20 cm, this purse is designed to be practical and accessible for soccer referees, ensuring they have all the essential items at hand during a game.

ART. 1900004100



## LINESMAN FLAG OFFICIAL SWIVEL - DIAMOND

The Linesman Flag official Swivel – Diamond, perfect for national and international matches. Crafted from high-quality polyester, these flags feature a rotating system for smooth movement. The PVC handle with a sponge grip ensures comfort, while the 55 cm length provides excellent visibility. This set of 2 flags comes complete with a branded bag for convenient storage and transportation. Ideal for referees, coaches, and sports officials across various sports.

ART. 1900001150



## REFEREE CARD SET

The Referee card set is a set of 2 penalty cards for referees, including a yellow card for caution and a red card for sending off players. These weather-resistant cards are made of H-PVC, ensuring durability in all conditions. With dimensions of 12 x 9 cm and round edges, they provide a professional and safe signaling method. Suitable for use by trainers and referees, these cards offer a high signalling effect, making them essential for communicating penalties during matches.

ART. 1910003200

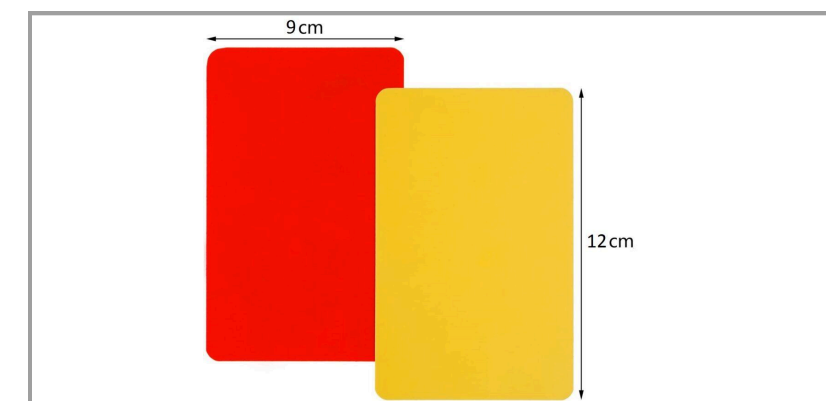



# ACCESSORIES



## TEXTILE LINE MARKER 48 M X 4 CM

The Textile Line Marker is an useful item for marking football pitches and beach volleyball courts. It is made of durable textile tape and is available in bright, highly visible colors. The marker comes in a convenient brand bag for easy transport and storage and includes 8 metal pegs and eyelets every 6 meters along its 48-meter length. It is designed for use in various weather conditions, ensuring it remains practical for use in any sports facility requiring accurate field markings.

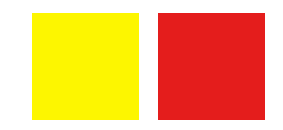

ART.  
4004860001R  
4004860001Y

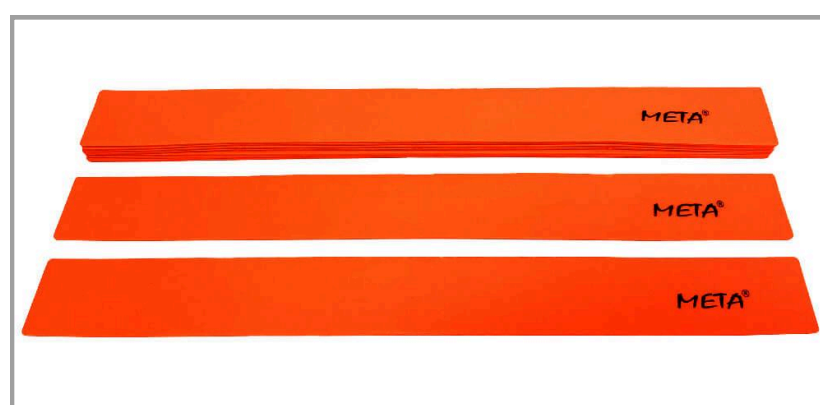
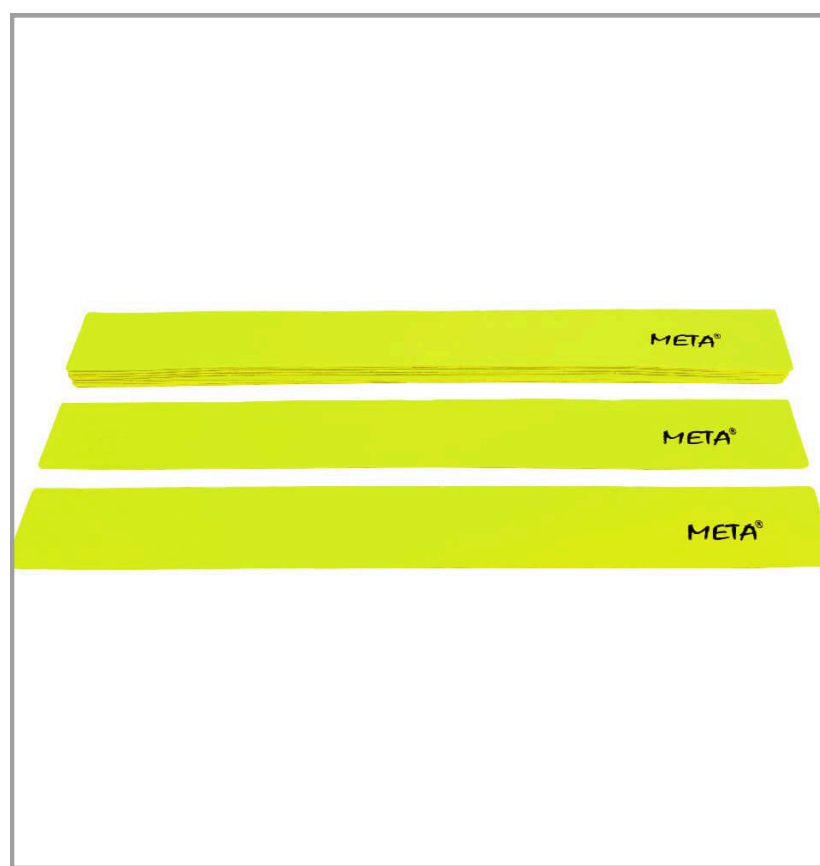

## FLAT LINE MARKER SET OF 10 PCS

The Flat Line Marker Set is perfect for coaches and athletes who need to create boundaries for their training sessions or games. The non-slip rubber strips ensure that the markers stay in place, even on slick surfaces. The set includes 10 pcs of flat line markers. With the dimensions of 3mm thickness, 50cm length, and 5.5cm width, these markers are large enough to be easily seen and are durable enough to withstand frequent use. They are performed in bright colors (lemon and orange). It makes easy to differentiate between zones. The compact brand bag makes it easy to transport the markers to and from training sessions.



ART.  
4010100100L  
4010100100O

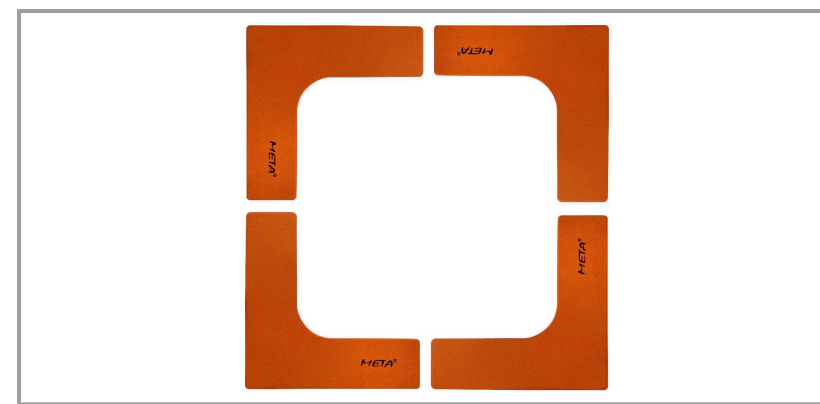
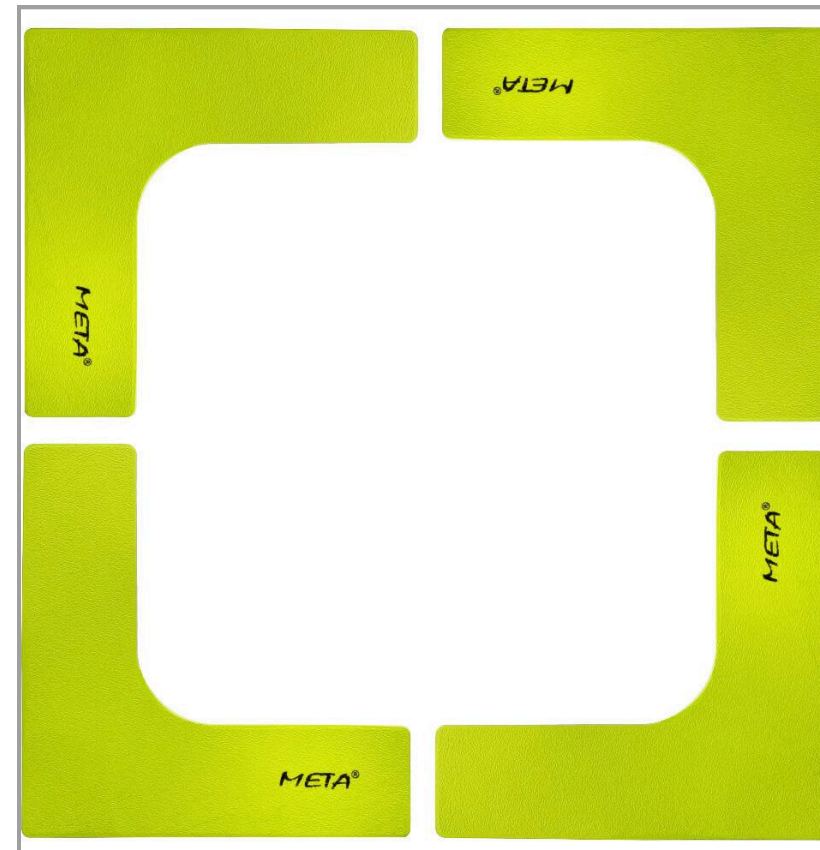

## FLAT CORNER MARKER SET OF 4 PCS

The Flat Corner Marker Set includes 4 pcs of corner markers and is perfect for marking and delineating play areas for team sports. Made from non-slip rubber, these 90° angle-shaped markers are durable and provide clear visibility on various surfaces. Each marker measures 6 cm in width and 25 x 25 cm in length, with a thickness of 3 mm. Available in lemon and orange colours and come in a compact bag for easy transportation and storage.



ART.  
4004000100L - LEMON  
4004000100O - ORANGE



## REFEREE PLASTIC WHISTLE

The Referee Plastic Whistle is specifically designed for coaches and referees, providing a simple and universal tool. Its durable plastic construction ensures that it can withstand regular use in various sports and activities. It is equipped with a cork core to produce a clear and loud sound, ensuring that it can effectively grab the attention of players during games. The whistle is compact and easy to carry, making it convenient for usage. While it does not include a lanyard, it has a metal ring that allows for easy attachment.

ART. 1030001204



## WHISTLE PLASTIC CLASSIC WITH LANYARD

The Whistle plastic classic with lanyard is a must-have for referees in various sports. Its reliable design and top-notch quality have made it highly sought after by coaches and referees. It is available in three different colors, and its appealing packaging makes it an ideal gift option. The whistle is crafted from durable materials and produces a clear, loud sound that carries well on the field or court. It is also ergonomically designed for comfortable and prolonged use. Whether you're a coach, referee or plan to use it for other aims, this whistle will be an invaluable tool for its user.



ART.  
1010002401 – BLACK  
1020001202 – BLUE  
1030001203 – RED



## PLASTIC WHISTLE VIKING

The Plastic Whistle Viking is the model, known as a “cork ball whistle,” features a distinctive design with a cork core. It is a dependable and straightforward tool, ideal for various sports and outdoor activities. While it does not come with a lanyard, it includes a metal ring for lanyard attachment.

ART. 1030001205



## LANYARD FOR WHISTLES

The Lanyard for whistles is made of polyester and designed for convenient carrying of whistles during various activities. With a length of 48.5 cm, it features a durable metal clip. The strong and long-lasting polyester material ensures reliability. The lanyard can be worn on the neck or wrist, and its adjustable design makes it suitable for different sizes. Whether for sports, outdoor adventures, or emergency situations, this lanyard provides a practical and dependable way to keep a whistle close at hand.

ART. 1030001206



## BALL PUMP WITH OUTSIDE TUBE

The Ball pump with outside tube is a highly popular and convenient tool for inflating sports balls. Constructed from durable polypropylene, this double-action pump includes a 19 cm long tube and an additional metal needle housed inside the handle. The pump's versatility, practical design and efficient performance make it suitable for coaches, athletes, and sports enthusiasts choice across a wide range of sports worldwide.

ART. 1902000502

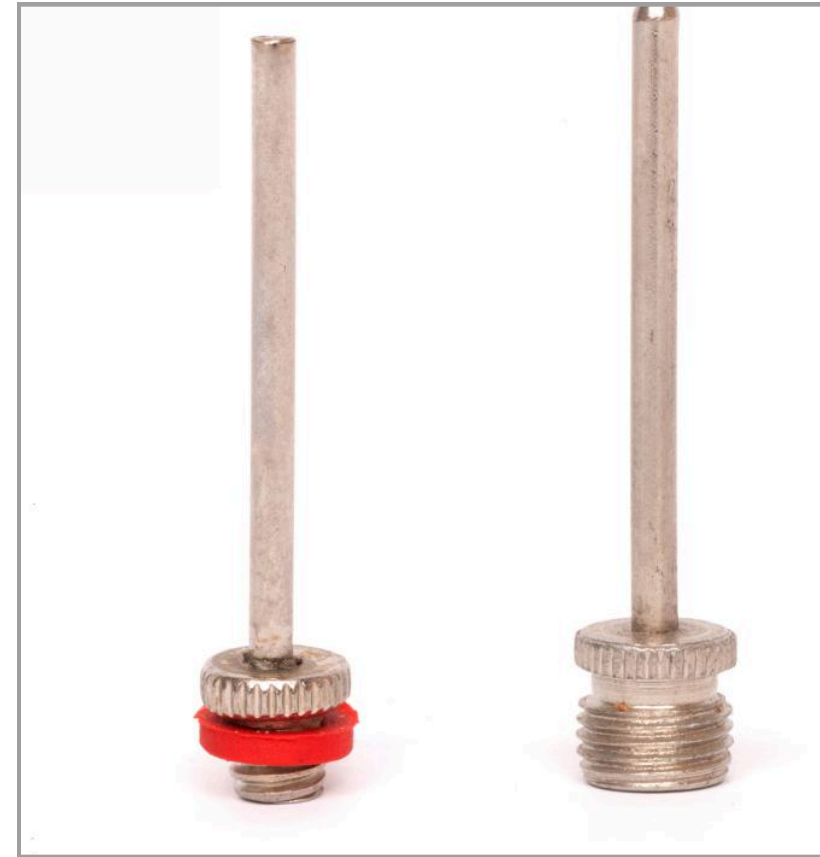

## INFLATING NEEDLES SET OF 5 PCS

The needle sets for all types of pumps with steel tip designs. A necessary attribute for inflating balls. Set includes 5 needles

ART.  
1950310001 - EUROPEAN  
1950310002 - AMERICAN



## AIR PUMP FOR DUMMIES

The Air Pump to Inflatable Soccer Dummies, Fitballs, Bosu designed for inflating different inflatable products. This compact yet powerful air pump stands at 29 cm tall and features a unique nozzle designed to accommodate three different sizes of air holes, making it a convenient and practical tool for sports coaches and fitness trainers. Its compact size makes it easy to transport and store, while its powerful performance ensures quick and hassle-free inflation.

ART. 2003068612



## ARMBAND WITH VELCRO CLOSURE

The Armband with Velcro Closure, designed with a bright pattern and a distinct capital letter "C" for easy visibility. Available in a range of vibrant colors, the armband features a Velcro closure for adjustable sizing, ensuring a comfortable fit for users of all ages. Made from high-quality elastic material, it provides flexibility and durability, making it suitable for a variety of sports. For sports where the armband takes place this products is an essential accessory for teams leaders.

ART. 1902240003

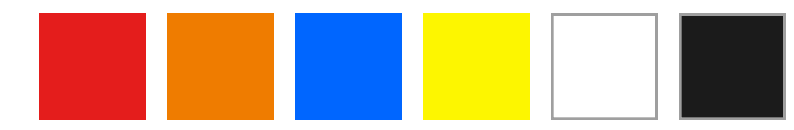



## 12 BOTTLE CARRIER PLASTIC

The 12-bottle container is a durable and convenient carrying basket with a central ergonomic handle and internal dividers. It is ideal for storing and transporting water bottles and other beverages. Made of impact-resistant plastic, it features light weight, stability, and a practical modern design.

ART. 2110001200



## 6 BOTTLE CARRIER PLASTIC FOLDABLE (BLUE)

The 6 Bottle Carrier Plastic Foldable is a high-strength plastic carrier designed to hold 6 bottles with a capacity of up to 750mm. Its practical and easy-to-use design allows for complete folding when not in use. The 6 individual cells measure 8 x 8 cm, providing a secure fit for your bottles. It is a good solution for trainings and different events apart from sport, any occasion requiring bottle transportation.

ART. 2110006250



## WATER BOTTLE BIO 750 ML

The Water Bottle Bio is made from a bio-based plastic material processed from sugar canes, making it an environmentally friendly and sustainable choice. The bottle boasts a sleek and uncomplicated design, featuring a screw cap with a retractable spout for convenient drinking. The 750ml capacity bottle is crafted from biodegradable plastic, allowing it to decompose quickly without emitting toxic substances. Its transparent construction not only makes it suitable for different bottle carriers. With a diameter of approximately 7.5 cm, it is a practical and eco-conscious option for staying hydrated on the go.

ART. 2207500750



## 8 BOTTLE CARRIER PLASTIC FOLDABLE

The 8 Bottle Carrier Plastic Foldable is a high-strength plastic carrier designed to hold 8 bottles with a capacity of up to 750mm. Its practical and easy-to-use design allows for complete folding when not in use. The 8 individual cells measure 8 x 8 cm, providing a secure fit for your bottles. It is a good solution for trainings and different events apart from sport, any occasion requiring bottle transportation.



ART.  
2110008250 - BLUE  
2110008251 - BLACK



# TACTIC BOARDS



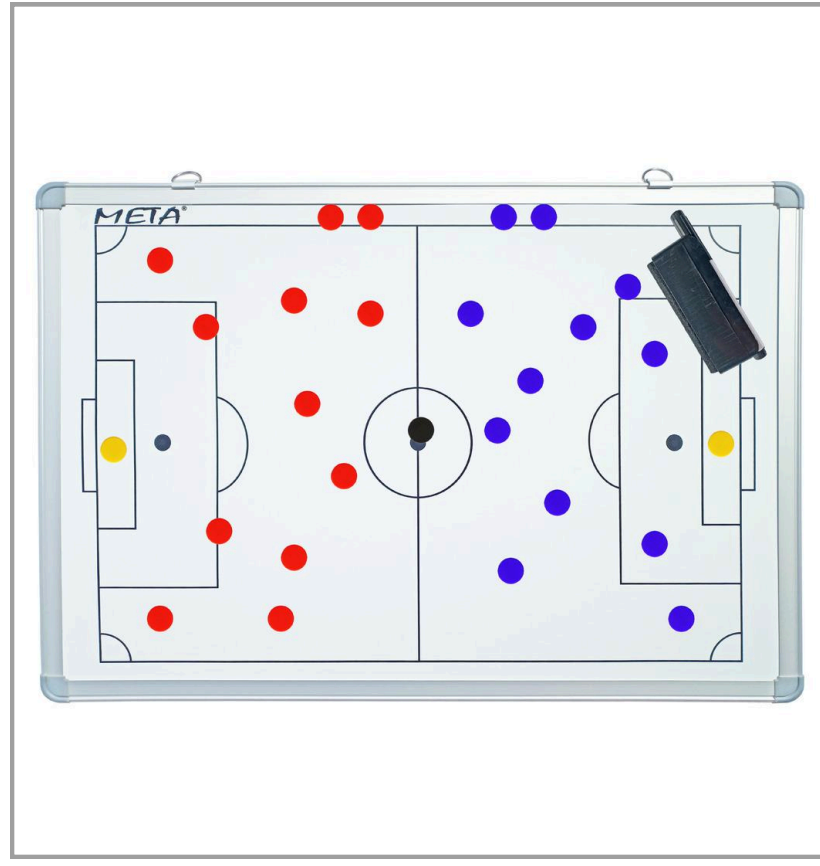

## MAGNETIC TACTIC BOARD

The Magnetic Tactic Board is an essential tool for any coach working with a team, this tactic board is made with an aluminum frame and a magnetic lined board. The set includes magnetic chips, a marker, and an eraser, making it ideal for tactical exercises for all types of teams. Available in various sizes including 30\*45 cm, 45\*60 cm, and 60\*90 cm, this tactic board is durable and versatile, providing coaches with the means to effectively plan and strategize with their teams.

- ART.  
 1900002100 - 30X45 CM  
 1900012100 - 45X60 CM  
 1900022100 - 60X90 CM



## MAGNETIC TACTIC BOARD BAG

The Magnetic Tactic Board Bags are designed to fit a variety of magnetic tactic boards. They come in different sizes to accommodate the dimensions and designs of your tactic board. The bags are made of durable factory fabric and feature handles and zippers for easy carrying. Inside, there are pockets to hold magnetic chips, markers, erasers, and other accessories. The bags are available in the color black and come in sizes of 30 \* 45 cm, 45 \* 60 cm, and 60 \* 90 cm.

- ART.  
 1930450050 - 30X45 CM  
 1945600050 - 45X60 CM  
 1960900050 - 60X90 CM  
 1960901050 - FOLDABLE 60X90 CM

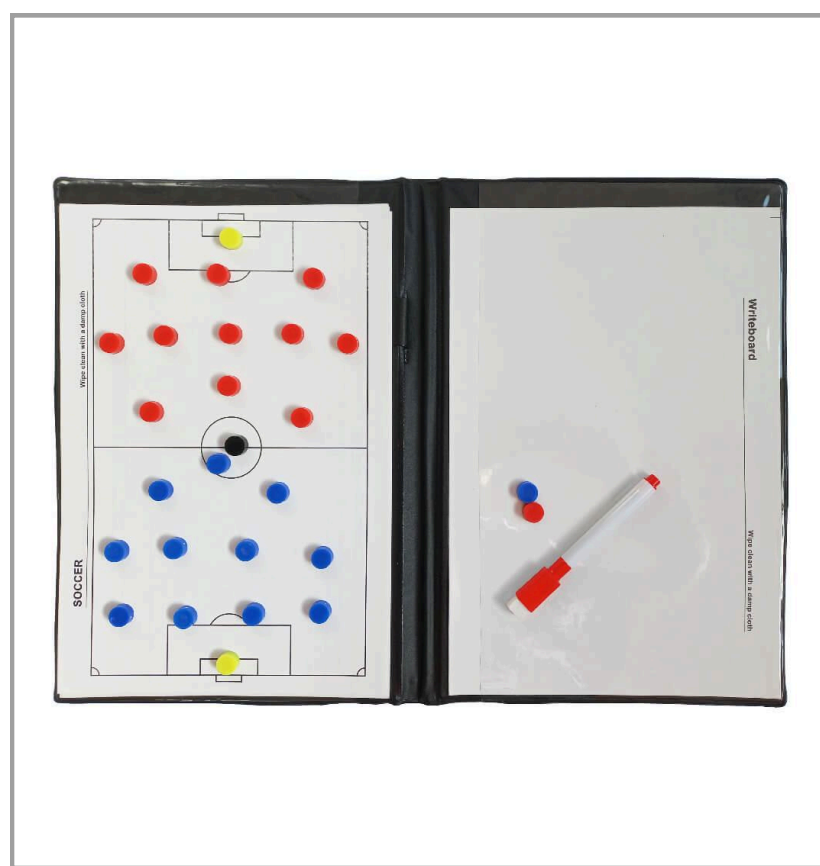

## MULTI SPORT FOLDER

The Multi Sport Folder is a versatile coaching tool suitable for a wide range of sports. Made from high quality PVC fabric, this 30 x 20 cm folder includes fields for Basketball, Volleyball, Handball, Football, Futsal, Tennis, Badminton, Ice Hockey, Rugby, and Floorball. It features an easy wipe-off surface, a dry erase marker, and magnets for convenience. The folder comes in a branded bag with zippers, making it easy to store and transport. Ideal for coaches looking for a practical and comprehensive solution for multiple sports.

- ART. 1900004301



## MAGNETIC TACTIC BOARD-FOLDABLE

The Magnetic Tactic Board-Foldable is a crucial tool for coaches working with sports teams, this tactic board features an aluminum frame and a magnetic surface. It comes with magnetic chips, a marker, and an eraser, making it ideal for tactical exercises and strategy planning. The foldable design allows for easy storage and transport, and it's available in a size of 60\*90 cm to accommodate different space requirements. This board is essential for coaches seeking to effectively illustrate and discuss game tactics and strategies with their teams.

- ART. 1900014100 - 60X90 CM





## MAGNETIC TACTIC BOARD- FOLDABLE HANDBALL

The Magnetic Tactic Board-Foldable Handball is a crucial tool for coaches working with sports teams, this tactic board features an aluminum frame and a magnetic surface. It comes with magnetic chips, a marker, and an eraser, making it ideal for tactical exercises and strategy planning. The foldable design allows for easy storage and transport, and it's available in a size of 60\*90 cm to accommodate different space requirements. This board is essential for coaches seeking to effectively illustrate and discuss game tactics and strategies with their teams.

ART. 1900014101

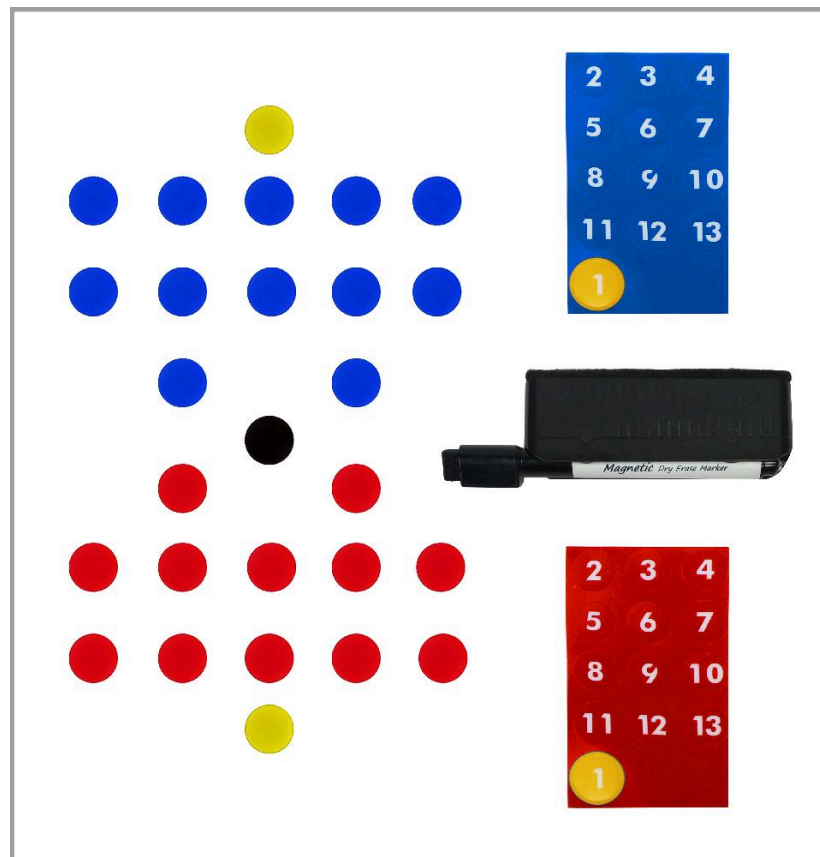
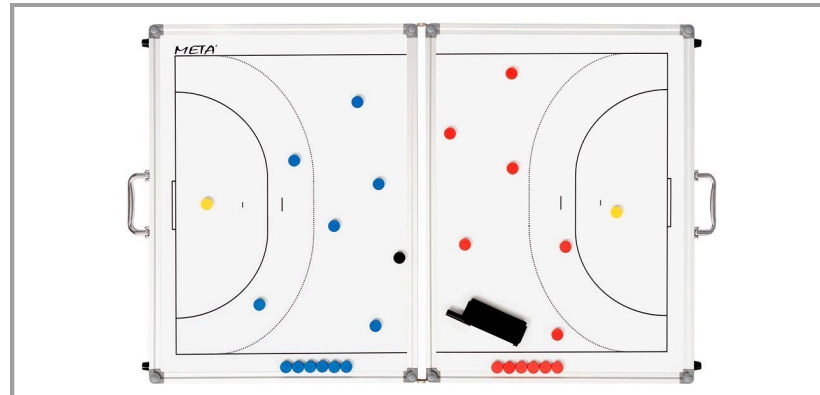

## SET OF MAGNET, MARKER, DUSTER

The Set of Magnet, Marker, Duster is a set of necessary attributes for each type of tactic board. The set includes 27 different coloured magnetic chips (22 players of two teams, goalkeepers of two teams, referee and 2 additional chips), a marker and an eraser.

ART. 1930000200



## TACTIC BOARD TRIPOD

The Tactic Board Tripod is a sturdy and reliable steel tripod designed for use with tactic boards of all sizes. Its high-quality powder coating ensures durability, making it perfect for daily use at training bases, sporting camps, and club academies. The tripod features telescopic adjustable legs, allowing for easy height adjustment up to a maximum of 160 cm. It also includes a convenient carrying bag for easy transportation and storage. Whether it's for soccer, basketball, or any other team sport, this tripod is an essential tool for coaching staff.

ART. 1900032100

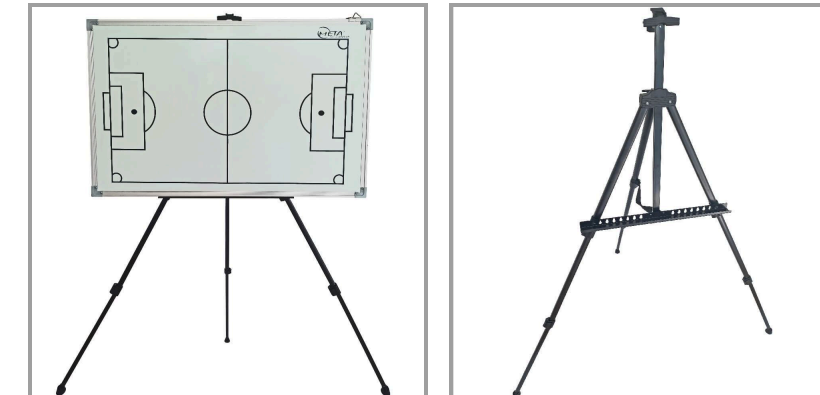



BAGS

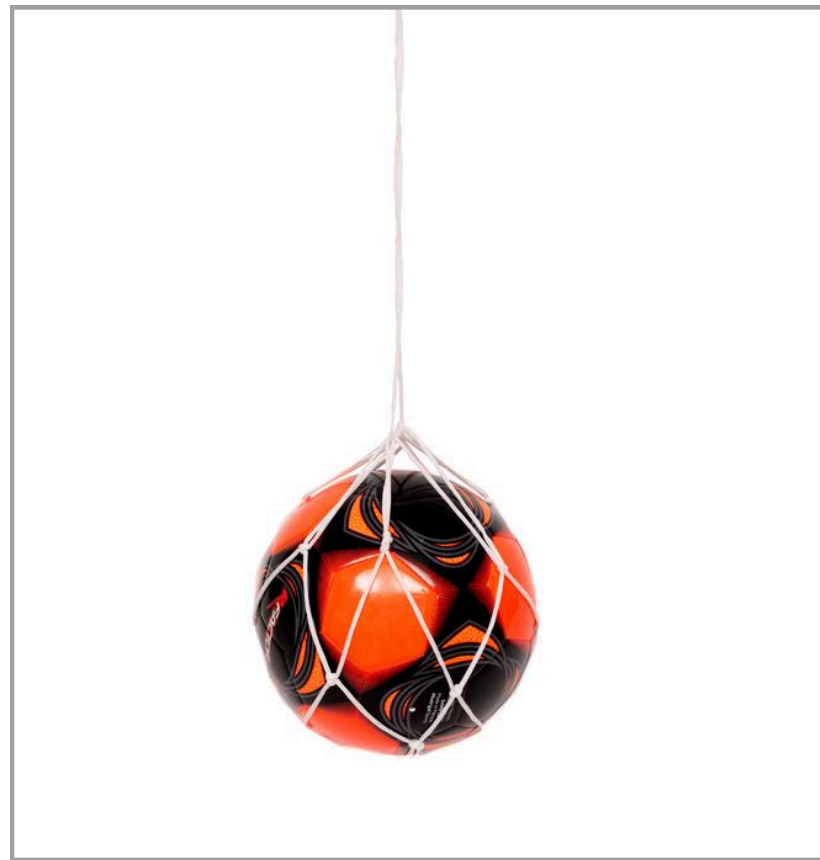

## SINGLE BALL CARRING NET

The Single Ball Carrying Net, made from double-weave HDPE material with a 2mm thick thread. This compact and portable product is designed for easy transport of one ball. Perfect for athletes and sports enthusiasts needing a convenient and durable solution for carrying their ball.

ART. 1901101000



## TUBULAR BALL SACK - BAG

The Tubular Ball Sack-Bag is made of high-strength polyester fabric with a geotextile structure, making it durable and long-lasting. It features comfortable straps/handles for easy carrying and transportation. The bag can accommodate up to 5 balls simultaneously and has dimensions of 110 cm in length and 36 cm in width. Whether you are a coach, an athlete, or a sports enthusiast, this bag is a practical and reliable option for transporting your sports equipment.

ART. 1900007200



## BALL CARRING NET

The Ball Carrying Net is made of double-weaved PE and has a leash at its top for tightening. Depending on the model, the nets can carry from 6 to 8, from 10 to 12 and from 14 to 16 balls. They are designed for outdoor use and are weather-resistant, suitable for various sports and activities. The easy setup and portability make them a versatile option for use them indoor and outdoor.

ART.  
1906801301 - 6-8 BALLS  
1910121301 - 10-12 BALLS  
1914161301 - 14-16 BALLS



## SOCCER BALL BAG FOR 10-12 BALLS

The Soccer Ball Bag for 10-12 balls is designed specifically for coaches and their assistants. This bag has the capacity to store between 10 and 12 balls. It has a shoulder strap that makes it easy to carry and a string for fixing the bag closed. This model of the bag is very practical and comfortable accessory for coaches and their assistants.

ART. 1912150210



## SOCCKER BALL BAG MAXI

The Soccer Ball Bag Maxi, a versatile and essential accessory for soccer teams, coaches, and assistants. This spacious bag is designed to comfortably hold 15 or more soccer balls, making it ideal for training sessions and matches. With convenient front pockets featuring zippers for storing training bibs, and additional small pockets at the bottom for a ball pump and other necessities, this bag is designed for practicality and organization. Equipped with a strong shoulder strap, the bag provides easy carrying of markers or cones, ensuring all essential equipment is readily accessible. It also offers comfortable and hands-free transportation. Constructed from durable and water-resistant materials. This bag is built to regular use and providing long-lasting reliability. The Soccer Ball Bag Maxi is the ultimate solution for transporting and storing soccer balls and equipment with ease and efficiency.

ART. 1912150211



## MATCH BALL BAG

The Match Ball Bag is made from sturdy 600D nylon and comes with an adjustable strap for easy carrying. Inside, it has cardboard dividers that are attached to the bag with velcro, allowing for stability for up to 6 fifth-sized balls. This specialized design has been rapidly gaining popularity among sports teams and players who require a reliable and convenient way to transport match balls. Its practicality, functionality, quality and design of the bag have made it a popular product.

ART. 1912150212



## WATER BOTTLE BAG

The Water Bottle Bag is constructed from heavy-duty fabric and can hold up to 12 bottles. It features a double zip with a Velcro closure and comes with a heavy-duty carry handle, making it ideal for team use.

ART. 2110008000



## SLALOM POLE BAG

The Slalom Pole Bag is made with durable, high-quality factory fabric and has about 190cm length that can hold up to 12 slalom poles. It is designed with convenient handles that make it easy to carry and transport the poles and other small sizes' tools for training.

ART. 1200005100



FIRST AID

META®  
Medical Bag



## MEDICAL BAG-MINI

The Medical Bag-Mini is designed to keep physicians' essential supplies organized and easily accessible. It features internal subsections and geotextile pockets with zippers, providing ample storage for medical tools. With dimensions of 25 cm in length, 8 cm in width, and 18 cm in height, it's a convenient and portable option for doctors and medical professionals to carry necessary items. It is also ideal for on-call doctors, first-aid kits, medical emergencies, and clinical settings. Please note that this bag does not include any medications.

ART. 1910000200



## MEDICAL BAG

The Medical Bag is tailored for the needs of medical professionals such as doctors and their assistants. It features internal compartments to accommodate various medical tools and supplies, and also includes external front and side pockets for convenient access. The bag's dimensions are 36 cm in length, 18 cm in width, and 30 cm in height. It's important to note that this product does not come with any medicines included, allowing users to personalize its contents according to their requirements and preferences.

ART. 1910000100



## MEDICAL BAG HANDY

The Medical Bag-Handy is a compact and convenient solution for medical professionals to carry essential tools and equipment. With dimensions of 35cm x 13cm x 19cm, this bag is designed with pockets and compartments to accommodate medical instruments. It also includes space for medical documentation and small electronic devices. Please note that this medical bag does not include any medication.

ART. 1910000150



# TOP 5



BALLS



## SOCCER BALL META PARTIDO

**UPPER CASING:** Premium high-solid PU surface with a texturized finish for optimal durability and long-lasting shape and size retention.  
**AIR CUSHION:** 3.0 mm HD EVA-based microcellular closed-cell foam.  
**AIR CHAMBER:** NR-based bladder. Equipped with an interchangeable needle-valve system.  
**PRINTS:** Reactive and cross-linked PU ink with shiny and scratch-resistant film.

ART.  
 5000000025 - 5S  
 5000000024 - 4S



## SOCCER BALL META CAMPO

**UPPER CASING:** High-quality PU material with a special coated textured surface for increased passing speed, laminated on a non-woven backing support of 1.2 mm.  
**AIR CUSHION:** 2 mm neoprene layer.  
**AIR CHAMBER:** Fitted with a butyl-molded double-sheeted bladder and an interchangeable needle valve system.  
**PRINTS:** Cross-linked PU ink with a shiny, scratch-resistant film.

ART.  
 5000000015 - 5S  
 5000000014 - 4S  
 5000000013 - 3S



## SOCCER BALL META COPA

**UPPER CASING:** TPU cover of 0.15 mm with a textured finish.  
**AIR CUSHION:** 3 mm cross-linked EVA foam.  
**AIR CHAMBER:** Fitted with a seamless cured latex balanced bladder.  
**PRINTS:** Reactive and cross-linked PU ink with a shiny, scratch-resistant film.

ART.  
 5000000035 - 5S  
 5000000034 - 4S  
 5000000034 - 3S



## REFLEX BALL

This Reflex Ball is indispensable equipment for goalkeeper training. Its unique shape makes the direction of the ball's bounce unpredictable during training, helping goalkeepers develop and improve their reflexes and coordination. The ball is easy to inflate using a standard game ball pump.  
**BALL SIZE:** 23 cm × 23 cm × 23 cm. The technical features of the materials allow it to be used both indoors and outdoors.  
**UPPER CASING:** TPU (thermoplastic polyurethane) with a glossy finish.  
**AIR CHAMBER:** Natural rubber (NR), reinforced with polyester thread, providing excellent long-term air retention.  
**PRINTS:** Reactive and cross-linked PU ink, glossy film, scratch-resistant.

ART. 5000000045



## SOCCKER BALL META TRAINING

**UPPER CASING:** Made with 100% PU film cover of 0.80 mm.  
**AIR CUSHION:** 3.5 mm crosslinked and modified foam. Closed cell with reflex memory.  
**AIR CHAMBER:** Fitted with wing less double sheet balanced rubber bladder with polyester threads to protect water intake. Interchangeable double protective needle valve system.  
**PRINTS:** PU ink, shiny film, scratch resistant.

ART.  
 5000000085 - 5S  
 5000000084 - 4S  
 5000000083 - 3S



## SOCCKER BALL META MISTERIO

**UPPER CASING:** Polyester/ether copolymer TPU cover glacier white texturized finish 0.15 mm.  
**AIR CUSHION:** 3.0 mm HD EVA based microcellular closed cell foam.  
**AIR CHAMBER:** Fitted with wing less double sheet balanced rubber bladder with polyester threads to protect water intake. Interchangeable double protective needle valve system.  
**PRINTS:** PU ink, shiny film, scratch resistant.

ART.  
 5000000095- 5S  
 5000000094 - 4S  
 5000000093 - 3S



## SOCCKER BALL META MAXIMA

**UPPER CASING:** Soft touch advanced textured durable PU laminated on non woven backing support 1.0 mm.  
**AIR CUSHION:** 4.0 mm crosslinked and modified foam. Closed cell for smooth panel leveling with reflex memory, ideal rebound and playability.  
**AIR CHAMBER:** Fitted with wing less double sheet balanced butyl bladder reinforced with fabric patches to protect water intake, ultimate speed and rebound, interchangeable double protective needle valve system.  
**PRINTS:** Reactive & cross linked PU ink, shiny film, scratch resistant.

ART.  
 5000000105 - 5S  
 5000000104 - 4S



## FUTSAL BALL META MATCH

**UPPER CASING:** Premium high-solid PU surface with a texturized finish for optimal durability and long-lasting shape and size retention.

**AIR CUSHION:** 3.0 mm high-density EVA-based microcellular closed-cell foam with high memory return.

**AIR CHAMBER:** Butyl bladder reinforced with polyester. Features an interchangeable needle-valve system.

**PRINTS:** Reactive and cross-linked PU ink with a shiny, scratch-resistant film.

ART. 5000000054



## FUTSAL BALL META DREAM

**UPPER CASING:** Ultra soft Hi-abrasion PU material texturized surface.

**AIR CUSHION:** 2.5 mm modified EVA foam.

**AIR CHAMBER:** Fitted with butyl bladder with polyester fibers inside.

**PRINTS:** Reactive & cross linked PU ink, shiny film, scratch resistant.

ART. 5000000064



## FUTSAL BALL META FLASH

**UPPER CASING:** High quality PU material special coated texturized surface.

**AIR CUSHION:** 2 mm modified EVA foam.

**AIR CHAMBER:** Fitted with butyl bladder with polyester fibers inside.

**PRINTS:** Reactive & cross linked PU ink, shiny film, scratch resistant.

ART. 5000000074

# META<sup>®</sup>

 STREET 31, BUILDING 514, 61B,  
CATARROJA (46470), VALENCIA, SPAIN

 [META-SPORT.COM](https://meta-sport.com)

 +34(666)144-791

 [INFO@META-SPORT.COM](mailto:info@meta-sport.com)

 [METASPORTSBRAND@GMAIL.COM](mailto:metasportsbrand@gmail.com)